

8.7 AND 9.8 kW

**mira**

**ADVANCE** **ATL**  
THERMOSTATIC

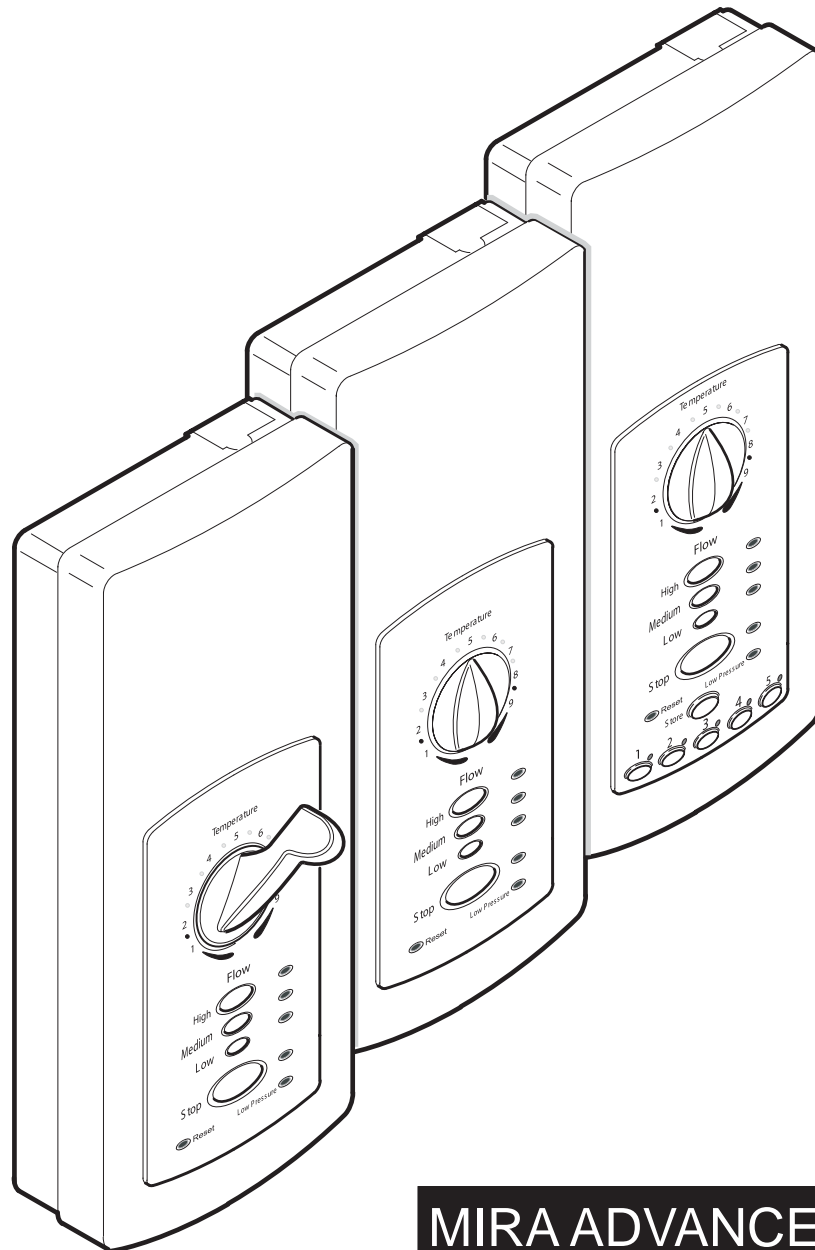

**MIRA ADVANCE ATL**

**ELECTRIC SHOWER**

**Installation & User Guide**

**These instructions are to be left with the user**

# CONTENTS

<b>Introduction</b> .....	<b>3</b>
<b>Important Safety Information</b> .....	<b>4</b>
<b>Pack Contents</b> .....	<b>6</b>
<b>Dimensions</b> .....	<b>7</b>
<b>Wiring Diagram</b> .....	<b>8</b>
<b>Specifications</b> .....	<b>9</b>
1. Plumbing .....	9
2. Electrical.....	9
3. Standards and Approvals .....	9
4. Patents .....	9
<b>Installation Requirements</b> .....	<b>10</b>
1. Plumbing .....	10
2. Electrical.....	12
<b>Installation</b> .....	<b>14</b>
Priming the Mira Advance ATL .....	17
<b>Commissioning</b> .....	<b>20</b>
<b>Operation</b> .....	<b>22</b>
1. How your Mira Advance ATL Shower Works .....	22
2. Using your Mira Advance ATL .....	24
3. Storing the Memory Presets (Memory Control Model only) .....	26
<b>Fault Diagnosis</b> .....	<b>27</b>
1. Users Troubleshooting Guide.....	27
2. Installers Troubleshooting Guide.....	29
<b>Maintenance</b> .....	<b>33</b>
<b>Maximum Temperature Setting</b> .....	<b>39</b>
<b>Spare Parts</b> .....	<b>40</b>
<b>Accessories</b> .....	<b>40</b>
<b>Notes</b> .....	<b>42</b>
<b>Customer Service</b> .....	<b>Back Page</b>

# INTRODUCTION

Thank you for purchasing a quality Mira product. To benefit from the full potential of your new shower, please take time to read this guide thoroughly, having done so, keep it handy for future reference.

The Mira Advance ATL is a high performance electric shower, which provides thermostatic temperature control which compensates for pressure, temperature and voltage changes to achieve very accurate water temperatures whilst showering. Separate push-button controls allow the user to easily select three independent flow settings.

The Mira Advance ATL features as standard, a safe "maximum temperature setting", but also benefits from a special feature allowing the maximum shower temperature to be limited to temperatures ranging between 37°C - 48°C.

The Mira Advance ATL Memory control model provides the user the opportunity to preset five choices of flow level and temperature, which can be easily recalled upon demand by simple push button control.

The Mira Advance ATL Flex is designed to be easily operated by users with restricted hand movement using ergonomically designed controls.

The Mira Advance ATL Extra models are designed to be used only with the following Whale Shower Drain Pump kits (supplied separately):

- SDP044T          Mira Whale Tray Kit (complete with 50 mm gully)**
- SDP054T          Mira Whale Wet Floor Kit (complete with wet gully for vinyl)**

For healthcare or special need requirements, refer to section: "**Maximum Temperature Setting**".

Mira Advance models covered by this guide:

<b>Mira Advance ATL Standard</b>	8.7 kW 240 Volts, 8.0 kW 230 Volts
<b>Mira Advance ATL Standard</b>	9.8 kW 240 Volts, 9.0 kW 230 Volts
<b>Mira Advance ATL Memory</b>	8.7 kW 240 Volts, 8.0 kW 230 Volts
<b>Mira Advance ATL Memory</b>	9.8 kW 240 Volts, 9.0 kW 230 Volts
<b>Mira Advance ATL Flex</b>	8.7 kW 240 Volts, 8.0 kW 230 Volts
<b>Mira Advance ATL Flex</b>	9.8 kW 240 Volts, 9.0 kW 230 Volts
<b>Mira Advance ATL Standard Extra</b>	8.7 kW 240 Volts, 8.0 kW 230 Volts
<b>Mira Advance ATL Flex Extra</b>	8.7 kW 240 Volts, 8.0 kW 230 Volts

If you experience any difficulty with the installation or operation of your new Electric Shower, then please refer to "**Fault Diagnosis**", before contacting Kohler Mira Ltd. Our telephone and fax numbers can be found on the back cover of this guide.

# IMPORTANT SAFETY INFORMATION

## 1. Warning!

**1.1** Products manufactured by us are safe and without risk provided they are installed, used and maintained in good working order in accordance with our instructions and recommendations.

**1.2 THIS APPLIANCE MUST BE EARTHED. MAKE SURE SUPPLEMENTARY BONDING COMPLIES WITH THE "REQUIREMENTS FOR ELECTRICAL INSTALLATIONS".**

In accordance with the current edition of 'The Plugs and Sockets etc. (Safety) Regulations' in force at the time of installation, this appliance is intended to be permanently connected to the fixed electrical wiring of the mains system.

**1.3 DO NOT** twist the individual cable cores of the live and neutral conductors, as this will prevent them from entering the terminal block.

**1.4** The shower unit must not be fitted where it may be exposed to freezing conditions. Make sure that any pipework that could become frozen is properly insulated.

**1.5 DO NOT** operate this appliance if it appears to be frozen. Allow the appliance to thaw and then contact your installer before using again.

**1.6 DO NOT** operate this appliance if water leaks from the Case. Maintenance may be required before the appliance can be safely used.

**1.7 DO NOT** fit any form of outlet flow control as the outlet acts as a vent for the tank body. Only Mira recommended outlet fittings should be used.

**1.8** There are no user serviceable components beneath the cover of this appliance. Only a competent tradesperson should remove the cover.

**1.9** If any of the following conditions occur, isolate the electricity and water supplies. Contact your installer or refer to 'To contact us', on the back page of this guide.

**1.9.1** If the cover is not correctly fitted and water has entered the appliance case.

**1.9.2** If the case is damaged.

**1.9.3** If the appliance begins to make an odd noise, smell or smoke.

**1.9.4** If the appliance shows signs of a distinct change in performance, indicating a need for maintenance.

**1.10** Isolate the electrical and water supplies before removing the cover.

**1.11** Mains connections are exposed when the cover is removed.

**1.12** Refer to the wiring diagram before making any electrical connections.

**1.13** Make sure all electrical connections are tight, to prevent overheating.

## **2. Caution!**

- 2.1** Read all of these instructions and retain this guide for later use.
- 2.2** Pass on this guide in the event of change of ownership of the installation site.
- 2.3** Follow all warnings, cautions and instructions contained in this guide, and on or inside the appliance.
- 2.4** The electrical installation must comply with the "Requirements for Electrical Installations" commonly referred to as the IEE Wiring Regulations, or any particular regulations and practices, specified by the local electricity supply company in force at the time of installation. The installation should be carried out by an electrician or contractor who is "Part P" (Building Regulations) registered, or is a member of, an association such as:
  - 2.4.1** National Inspection Council for Electrical Installation and Contracting (NICEIC), throughout the UK.
  - 2.4.2** The Electrical Contractors Association (ECA), England and Wales.
  - 2.4.3** The Electrical Contractors Association of Scotland (ECAS).
- 2.5** This appliance is a high power unit, it is essential to contact your electricity supply company to ensure that the electricity supply is adequate for the purpose.
- 2.6** The plumbing installation must comply with the requirements of UK Water Regulations/Bye-laws (Scotland), Building Regulations or any particular regulations and practices, specified by the local water company or water undertakers. The installation should be carried out by a plumber or contractor who is registered, or is a member of, an association such as:
  - 2.6.1** Institute of Plumbing (IOP), throughout the UK.
  - 2.6.2** National Association of Plumbing, Heating and Mechanical Services Contractors (NAPH & MSC), England and Wales.
  - 2.6.3** Scottish and Northern Ireland Plumbing Employers' Federation (SNIPEF), Scotland and Northern Ireland.
- 2.7** Anyone who may have difficulty understanding or operating the controls of any shower should be attended whilst showering. Particular consideration should be given to the young, the elderly, the infirm, or anyone inexperienced in the correct operation of the controls.
- 2.8** When this appliance has reached the end of its serviceable life, it should be disposed of in a safe manner, in accordance with current local authority recycling, or waste disposal policy.

# PACK CONTENTS



Tick the appropriate boxes to familiarize yourself with the part names and to confirm that the parts are included.

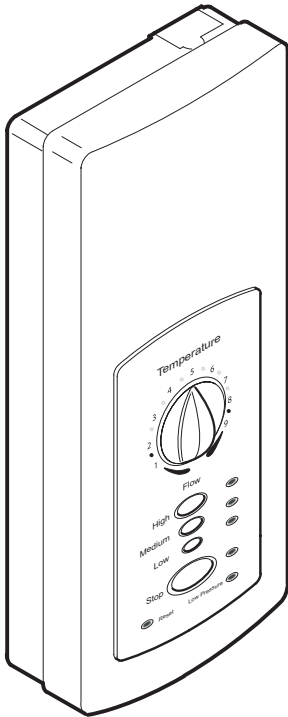

Or

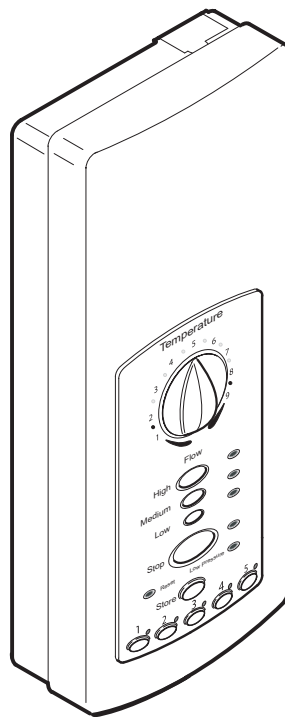

Or

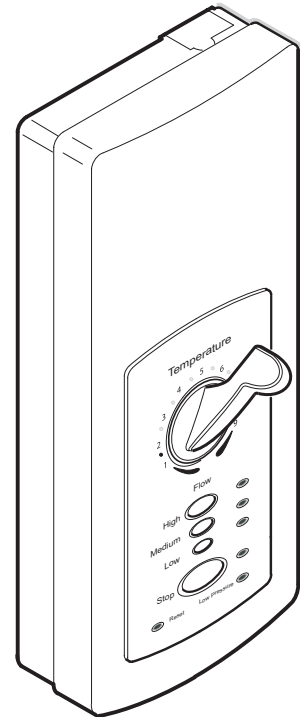

1 x Mira Advance ATL  
Standard or Standard Extra  
(Whale Shower Drain Pump  
supplied separately)

1 x Mira Advance ATL  
Memory

1 x Mira Advance ATL  
Flex or Flex Extra  
(Whale Shower Drain Pump  
supplied separately)

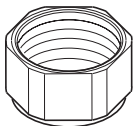

1 x Compression Nut

1 x Olive

1 x Tap Connector Adaptor  
(for fitting to existing tap connector)

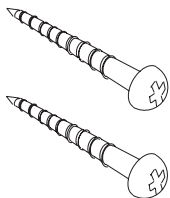

2 x Wall Screws

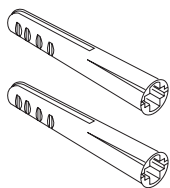

2 x Wall Plugs

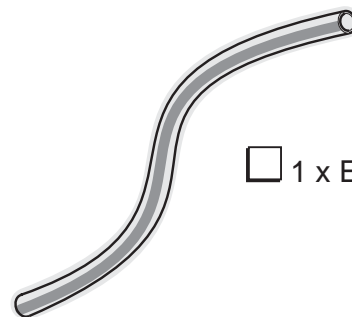

1 x Earth Sleeve

- 1 x Installation and User Guide
- 1 x Installer Checklist
- 1 x Installation Template
- 1 x Guarantee Card

# DIMENSIONS

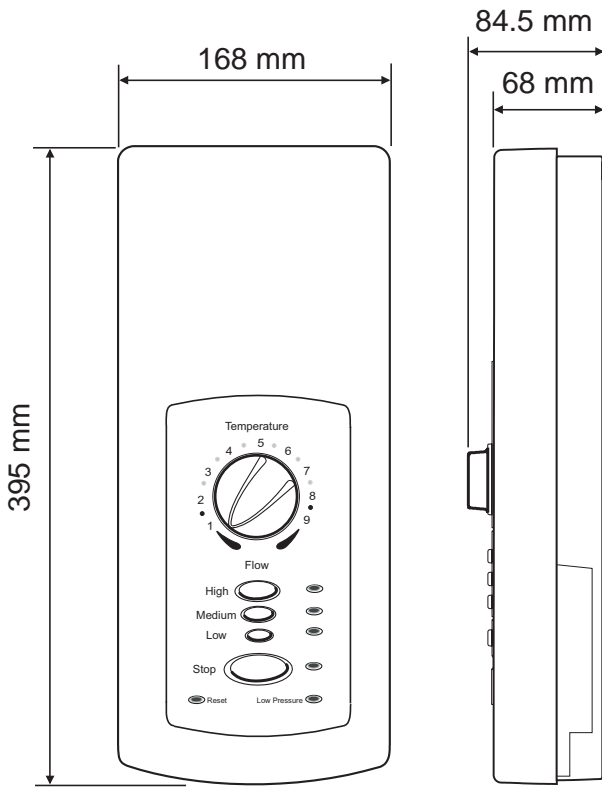

Advance ATL Standard

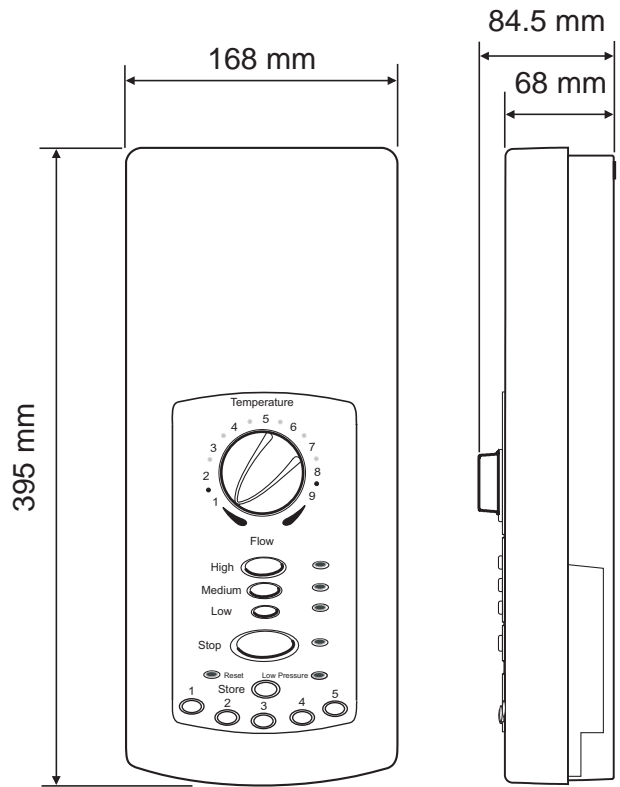

Advance ATL Memory

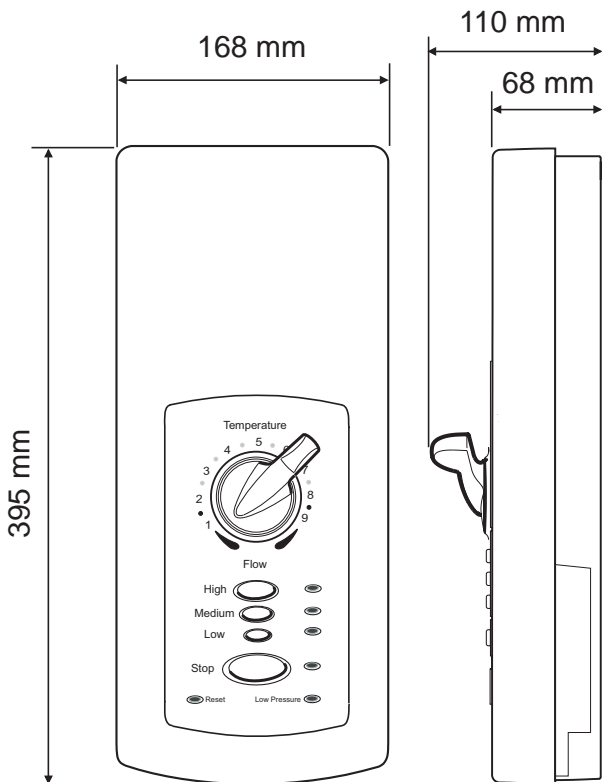

Advance ATL Flex

All dimensions are nominal

# WIRING DIAGRAM

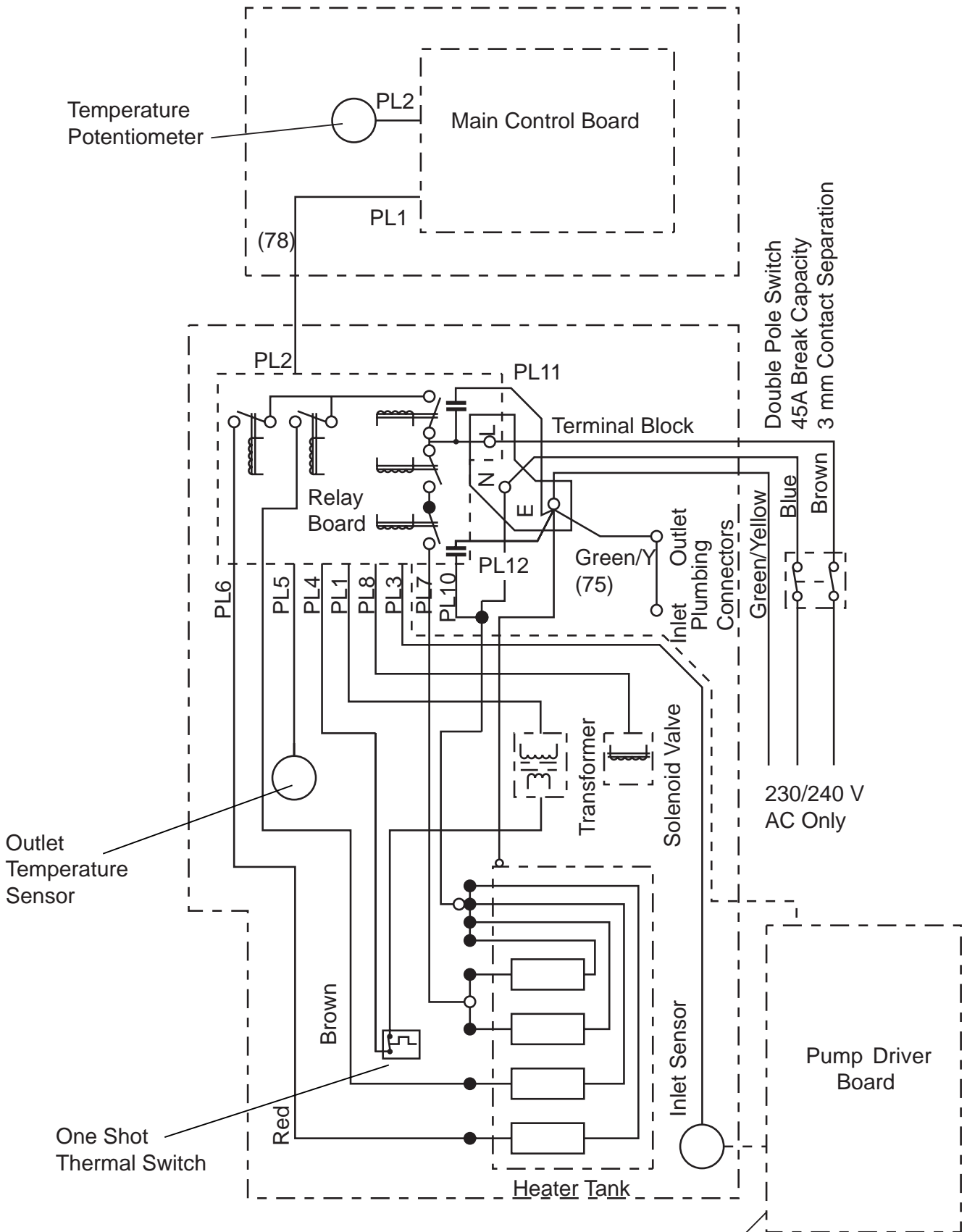

(fitted to Standard Extra and Flex Extra models only)



# SPECIFICATIONS

## 1. Plumbing

- 1.1** The inlet connector assembly incorporates an inlet filter. The connector can be turned to allow top, bottom or rear entry pipework.
- 1.2** The appliance outlet terminates with a 1/2" BSP male thread for connection to a Mira flexible shower hose.
- 1.3** A maintained pressure of at least **1 bar** is recommended for the product up to a maximum static pressure of **10 bar**.  
Thermostatic performance will be maintained down to **0.5 bar** maintained pressure. Operational pressures below **1.0 bar** may result in reduced flow.
- 1.4** Minimum static pressure of **0.2 bar** is required to keep the flow valve closed.
- 1.5** The Mira Advance ATL will provide satisfactory performance with incoming water supply temperatures between 2°C - 28°C.
- 1.6** Maximum ambient temperature for the Mira Advance ATL whilst in use is 30°C.

## 2. Electrical

- 2.1** Mira Advance ATL supply fuse -      8.7 kW 40 Amp  
  9.8 kW 45 Amp
- 2.2** The terminal block will not accept cable larger than 16mm<sup>2</sup>.
- 2.3** The Mira Advance ATL will provide satisfactory performance with an incoming electricity supply voltage of 230 V +/-10%.

## 3. Standards and Approvals

- 3.1** The Mira Advance ATL complies with the requirements of the BEAB Care Mark Standard and the relevant directives for CE marking.

## 4. Patents and Design Registration

Design Registration:	2 087 315, 2 087 316, D.13322, D.13320
Patents:	2269466, 2270370, 2298478, 2298479, 2298481

# INSTALLATION REQUIREMENTS

## 1. Plumbing

Refer to section: "**Important Safety Information**" first.

- 1.1 The Mira Advance ATL must be connected to the cold water mains-fed supply.
- 1.2 Do not use sealing compounds on any pipe fittings or joints.
- 1.3 Supply pipework **MUST** be flushed to clear debris before connecting the Mira Advance ATL. Debris will reduce the performance of the unit.
- 1.4 The Mira Advance ATL is suitable for installation within a shower area and must be positioned over a water catchment area with the controls at a convenient height for the user. The shower fittings should be positioned so that the handset discharges down the centre line of the bath, or across the opening of a shower cubicle, and must be directed away from the Mira Advance ATL.
- 1.5 The Mira Advance ATL is fitted with an inlet connector assembly that is designed to accept water supplies from the top or bottom. The water supply can be fed with 15 mm pipe or 10 mm microbore pipe, suitably adapted for the inlet connector assembly. If 10 mm microbore is used, then an allowance for increased pressure loss must be made to make sure that the minimum maintained inlet pressure of 1 bar is achieved, refer to section: "**Specifications**".
- 1.6 At pressures below 1 bar maintained the full flow performance may not be achieved.
- 1.7 The Mira Advance ATL must be fitted onto the finished wall surface i.e. on top of the tiles. Do not block the air ventilation gaps around the sides of the unit, either by tiling up to the sides of the unit or by using a sealant around the case (Small pillars moulded on to the back of the case allow air circulation). The appliance is designed to be ventilated. Failure to do this may cause product failure.
- 1.8 Use only the inlet connector assembly supplied with the Mira Advance ATL, do not use any other types of fitting.
- 1.9 When installing the inlet connector for rear inlet supply connection, refer to section: "**Installation**", it is advisable to seal around the incoming mains-fed supply to prevent water ingress into the wall. The compression nut must be accessible to allow for future adjustments.
- 1.10 We recommend that a non-restrictive (free flowing) isolating valve is fitted in the cold water supply pipe to allow maintenance of the Mira Advance ATL. Do not fit a valve that has a loose washer plate (jumper) as this can lead to a build up of static pressures.
- 1.11 Refrain from applying excessive force when making any connections. Always provide mechanical support when making the plumbing connections.

**1.12** To avoid damage to the Mira Advance ATL when soldered fittings are used, soldering must not be carried out in the vicinity of the unit as heat transfer can damage components.

**1.13** When installed in very hard water areas (above 200 ppm temporary hardness) your installer may advise the installation of a water treatment device, to reduce the effects of limescale formation. Malfunction of the Mira Advance ATL due to excessive limescale formation is not covered by the manufacturer's guarantee. Your local water company will be able to advise the hardness of water in your area.

**1.14** The Mira Advance ATL is fitted with a 1/2" BSP male outlet thread, to accept a Mira shower hose.

**1.15** The hose should be fitted through the hose retaining ring to prevent the handset from dropping below the spill-over level of the bath or shower, which could lead to contamination from backsiphonage. The hose retaining ring should meet the majority of user requirements for shower installations with flexible outlet fittings. However, there will be occasions when the hose retaining ring will not provide a suitable solution. In these instances an outlet double checkvalve, e.g. the Mira DCV-H, must be fitted, refer to section: "**Accessories**". The inclusion of the Mira DCV-H will increase the required supply pressure typically by 0.1 bar.

**Caution!** Double checkvalves, fitted in the inlet supply to the appliance, cause a pressure buildup, which could exceed the maximum static inlet pressure for the appliance.

**1.16** Avoid layouts where the shower hose will be sharply kinked. This may reduce the life of the hose.

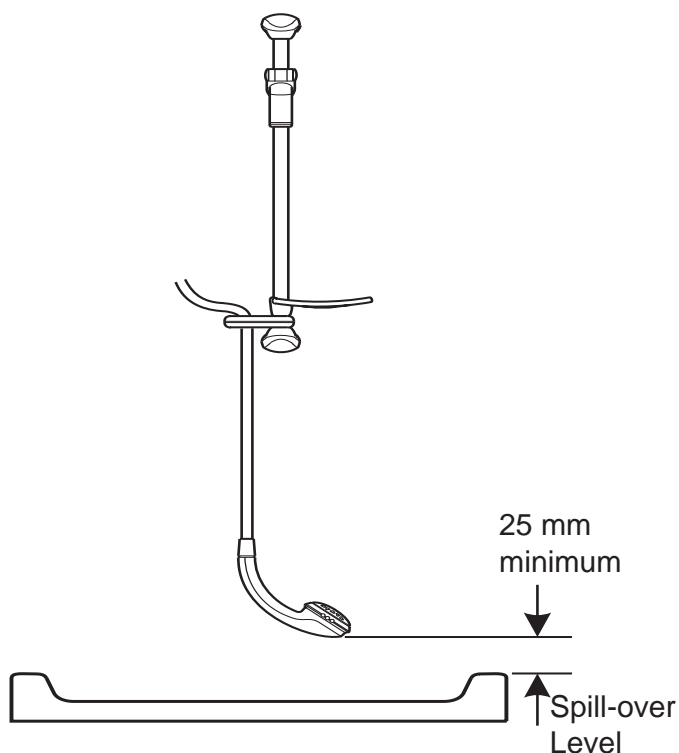

## 2. Electrical

Refer to section: "**Important Safety Information**" first.

**2.1** In a domestic installation, the rating of the electricity supplier's fuse and the consumer unit must be adequate for the additional demand. All Mira Advance ATL electric showers are high power units, therefore it is essential to contact your electricity supplier to make sure that the supply is adequate for the product. Voltage drop due to local heavy demand will reduce the shower's performance.

**2.2** The Mira Advance ATL must be earthed by connecting the supply-cable earth conductor to the earth terminal.

Supplementary bonding: Within the bathroom or shower room, all accessible conductive parts of electrical equipment and extraneous conductive parts (metal parts) that are likely to introduce earth potential, must be electrically bonded to earth using a minimum cable size of 4.0 mm<sup>2</sup> if the cable is not mechanically protected, (2.5 mm<sup>2</sup> if mechanically protected).

**2.3** The minimum required supply cable size must conform to BS 7671.

**2.4** As a guide only, and in accordance with BS 7671 we recommend close circuit protection:

i.e.      **8.7 kW = 40 Amp**

**9.8 kW = 45 Amp**

It is strongly recommended that a 30 mA Residual Current Device (RCD) is included in the electrical circuit. This may be part of the consumer unit or a separate unit.

A separate, permanently connected supply is taken from the consumer unit to the appliance through a double-pole switch, which has at least 3 mm contact separation. The switch can be a ceiling mounted pullcord type within the shower room or a wall mounted switch in an adjacent room.

**2.5 DO NOT** twist the individual cable cores of either the live or neutral conductors, as this will prevent them from entering the terminal block.

**2.6 DO NOT** exert strain on the terminal block. Make sure that the electrical connections are tightly screwed down.

**2.7 DO NOT** turn on the electrical supply until the plumbing has been completed.

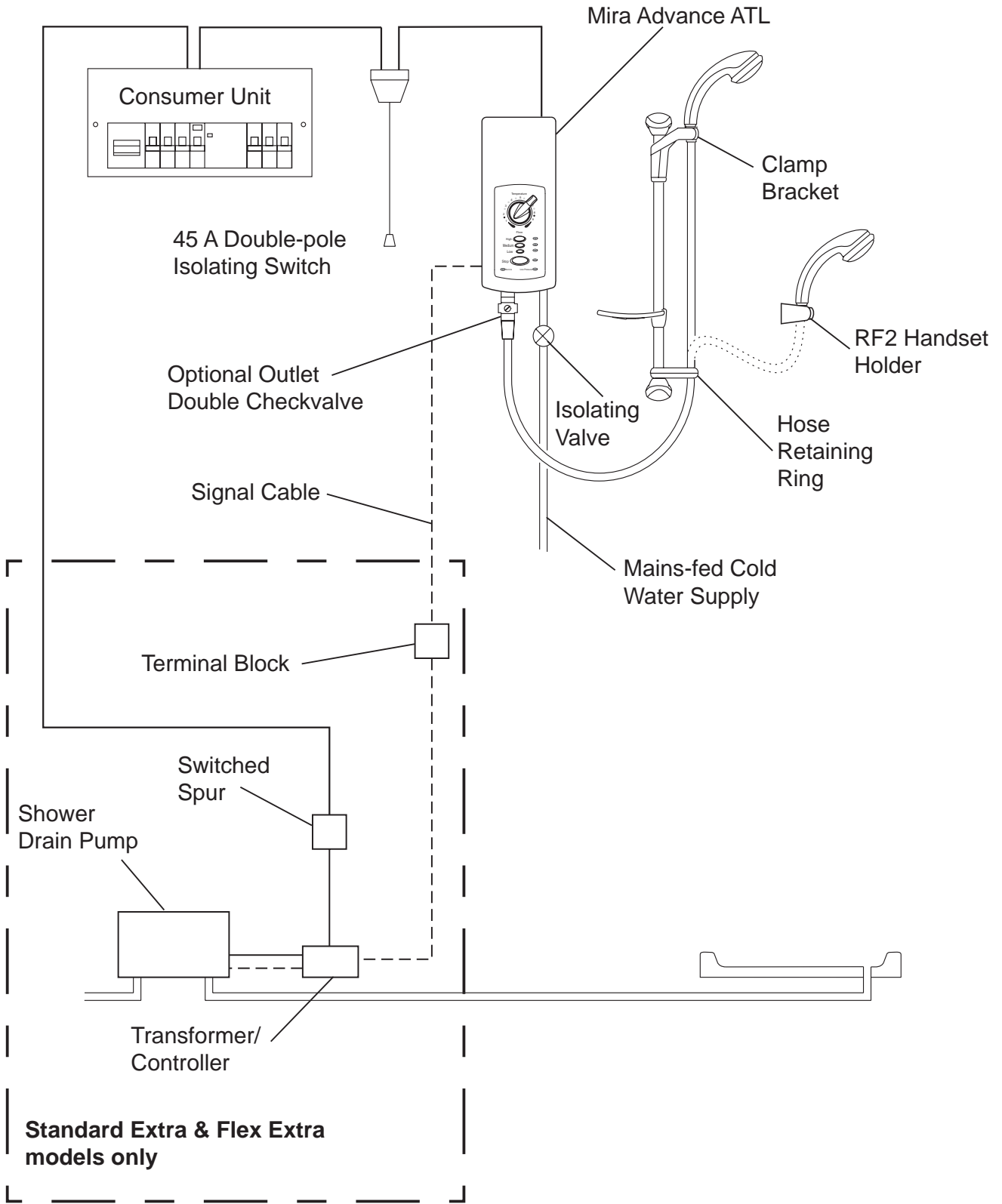

**Plumbing and Electrical Schematic Diagram**

# INSTALLATION

Refer to section: "Important Safety Information" first.

This installation covers all models of the Mira Advance ATL Thermostatic shower.

**Warning!** Isolate the electrical and water supplies before proceeding with the installation of the Mira Advance ATL. The electricity supply must be turned off at the mains and the appropriate circuit fuse removed, if applicable.

**Note!** Bottom inlet is illustrated for clarity in these instructions.

- 1.1 Unscrew the Case Securing Screw and carefully pull the bottom of the Cover outwards and upwards off the Case.
- 1.2 Remove the Inlet Shield, located over the Inlet Connector Assembly.
- 1.3 When deciding the position of the Mira Advance ATL on the wall, allow 100 mm minimum clearance to the right hand side of the case, to provide unrestricted access to the inlet connector, for installation and maintenance. Allow 10 mm minimum clearance from the top of the case to allow the cover to be removed.

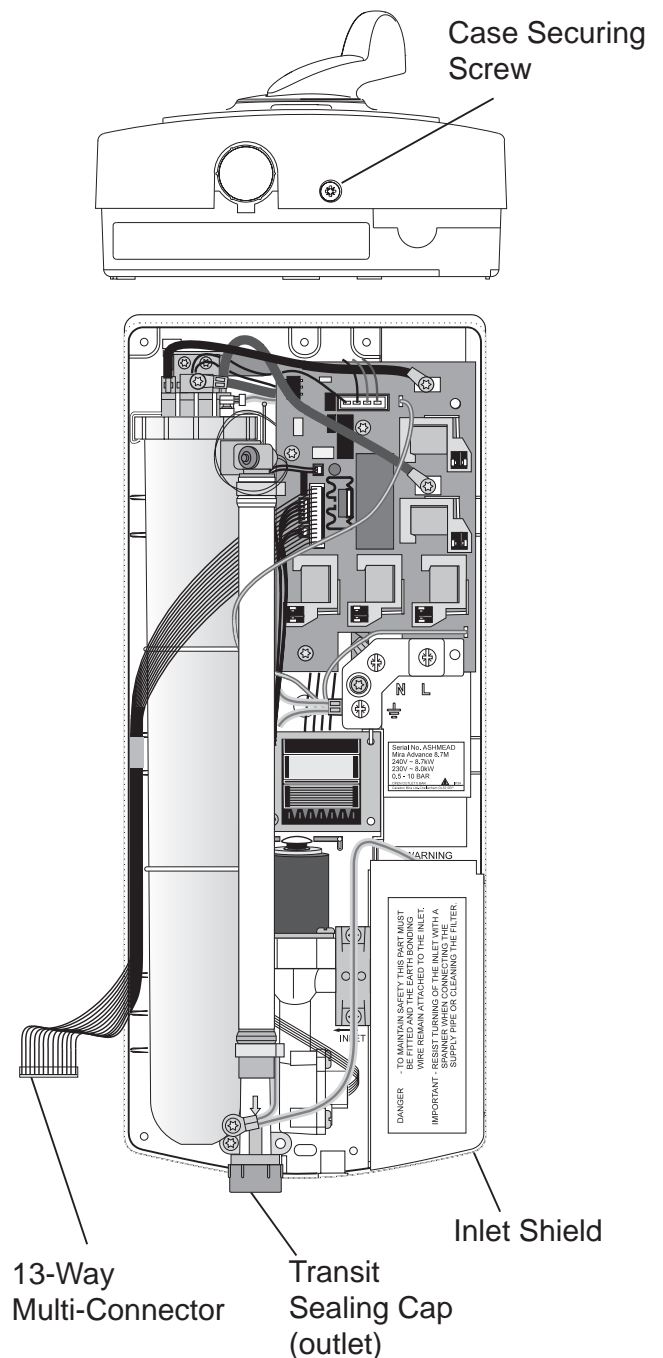

**1.4** Determine whether the cold water and cable supplies will be top (falling), bottom (rising), or rear inlet to the Mira Advance ATL. Provision must be made for routing the signal cable from the appliance to the Shower Drain pump (up to 2 m), this applies to the Standard Extra and Flex Extra models only.

**Note!** Rear inlet must allow access to the water supply pipe fittings.

**1.5** Turn the inlet connector assembly to suit the supply pipe position. Avoid trapping the green earth bonding wire.

**1.6** Remove as appropriate, the thinned sections in the Mira Advance ATL case, to allow the pipe and cable to enter the product.

**1.7** Install the mains-fed cold water supply pipe.

**Caution!** Do not use sealing compounds on any pipe fittings for the installation.

The Mira Advance ATL can be connected to either a compression fitting (supplied) or a tap connector (not supplied).

If upgrading from an existing shower that uses a tap connector, then the tap connector adaptor can be used in place of the fibre washer. This allows the tap connector to be used in conjunction with the compression fitting of the product (refer to illustration).

For rear inlet supplies, the cold water pipe must emerge from the surface of the wall 'square' to prevent straining the inlet connector clamp bracket. Refer to illustration for options.

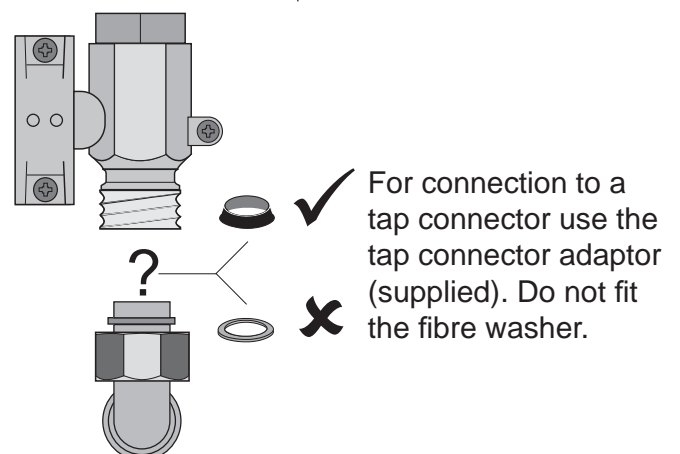
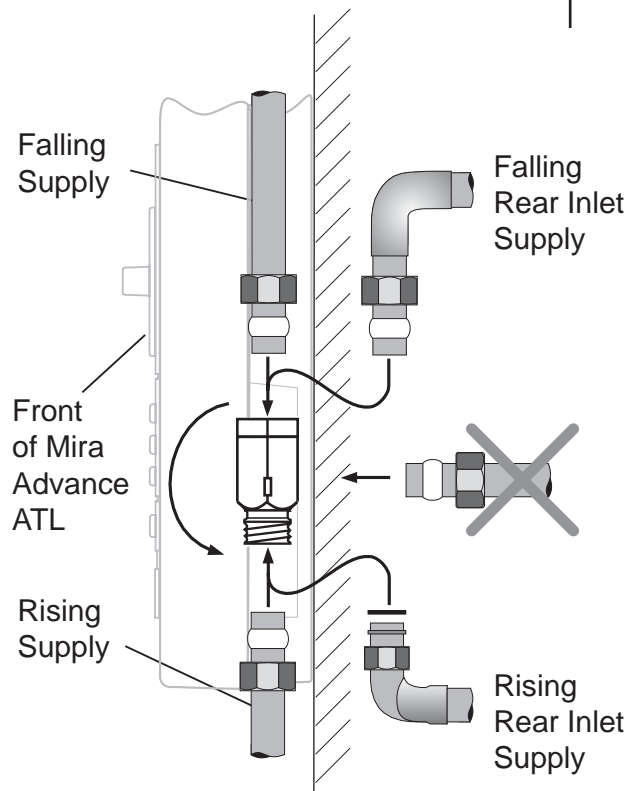
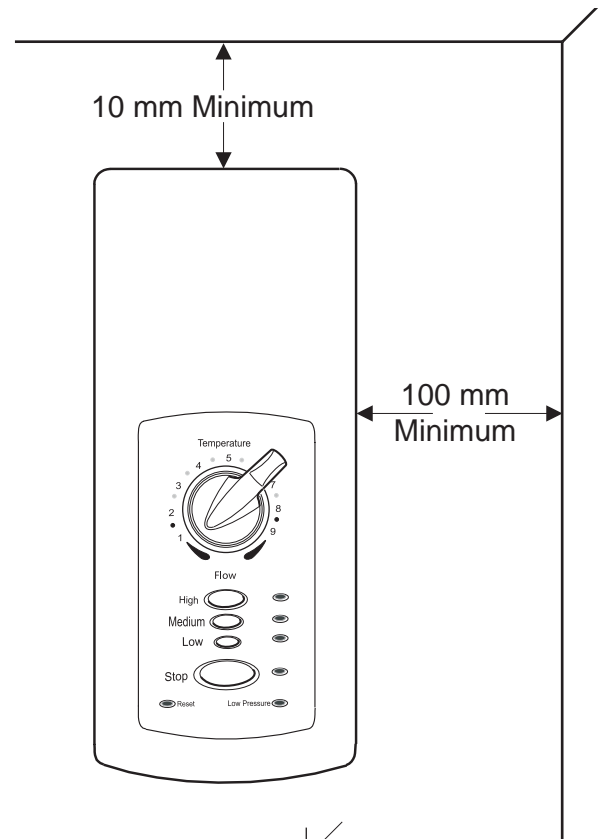



**1.8** Thoroughly flush the mains-fed cold water supply pipe. The water supply pipework must be clean and free from debris before connecting to the Mira Advance ATL.

**Note!** Pipework debris will reduce the performance of the unit.

To flush the pipework, turn on the water supply and drain a minimum of 10 litres (2 gallons) of water into a bucket or catchment area. Turn off the water supply.

**1.9** Avoiding buried cables and pipes, choose one of the upper fixing holes which will allow the Mira Advance ATL to be firmly fixed to the wall structure, and drill through the thinned hole section in the back of the case.

**1.10** Unscrew the transit sealing caps from the inlet and outlet of the Mira Advance ATL.

**Note!** A small amount of water may be released.

**1.11** Offer the Mira Advance ATL up to the wall and temporarily connect the mains-fed cold water supply pipe. Mark through the casing the position of the upper and lower holes. Remove the Mira Advance ATL from the wall before drilling. This will prevent debris from entering the Mira Advance ATL.

**1.12** Drill and suitably plug the two fixing holes. Route the Signal Cable to the Terminal Block located on the Transformer Cable of the Shower Drain Pump (Standard Extra and Flex Extra models only).

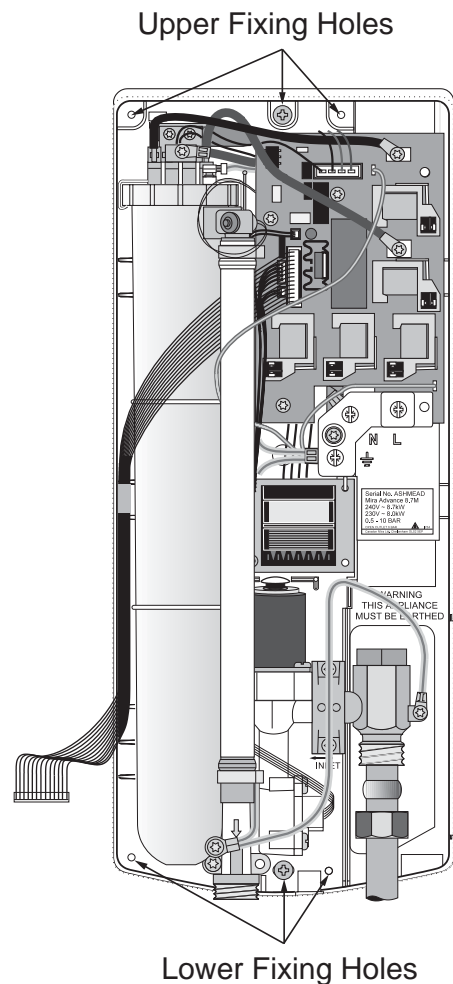

**Do not connect Signal Cable to mains Electricity Supply!**



**(Standard Extra and Flex Extra models only)**

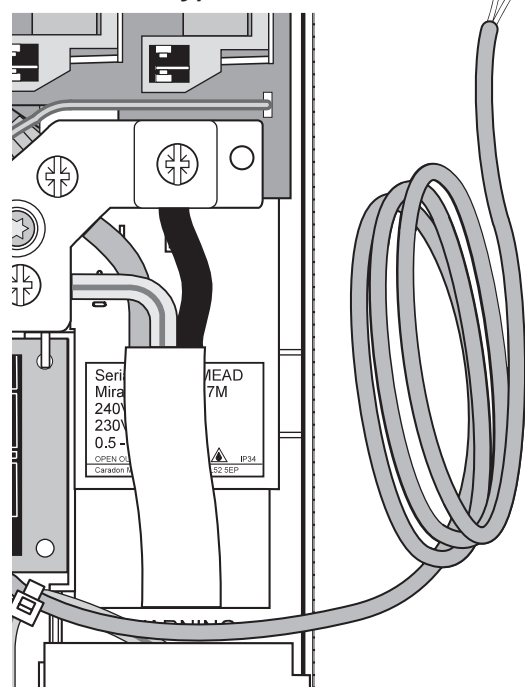



**1.13** Secure the Mira Advance ATL to the wall with the screws provided. Alternative fixings (not supplied) may be necessary for some wall structures.

Make the connection to the mains-fed cold water supply pipe, **DO NOT** allow debris to enter the inlet connector. Hold a wrench across the flats of the inlet connector assembly to prevent damage to the connector, whilst tightening the compression nut. Turn on the water supply and check for leaks.

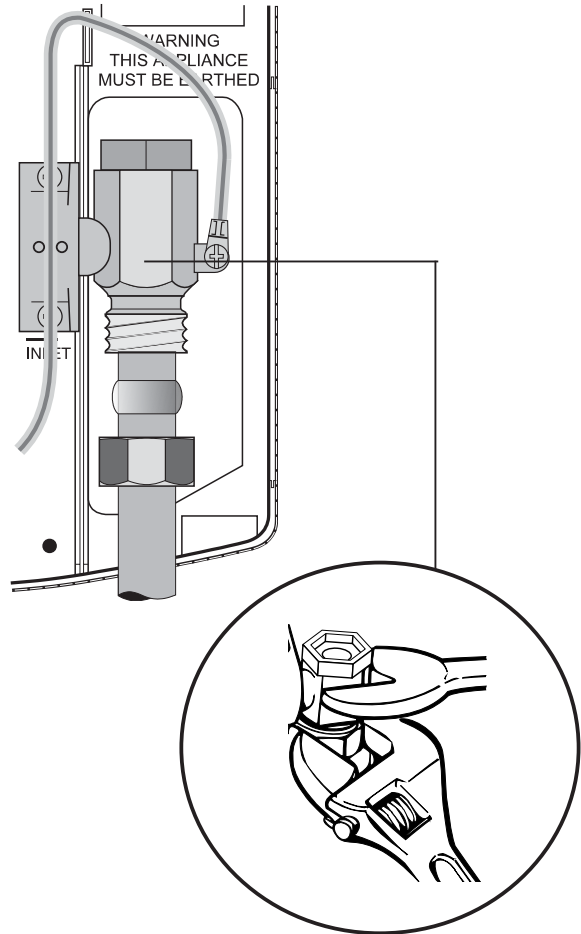

### Priming the Mira Advance ATL

**1.14** Connect the shower hose to the Mira Advance ATL and position the hose to discharge into the shower tray or bath waste outlet.

**1.15** Press down the air bleed button, located on top of the flow valve. This will allow the Mira Advance ATL to fill with water and expel any trapped air. A small amount of water must be discharged.

**Note!** Failure to prime the unit will severely affect performance.

**Note!** When the air bleed button is pressed water at full mains supply pressure will flow from the shower hose.

**Caution!** When the air bleed button has been pressed make sure that it does not foul when released, otherwise water will continue to discharge from the bleed button.

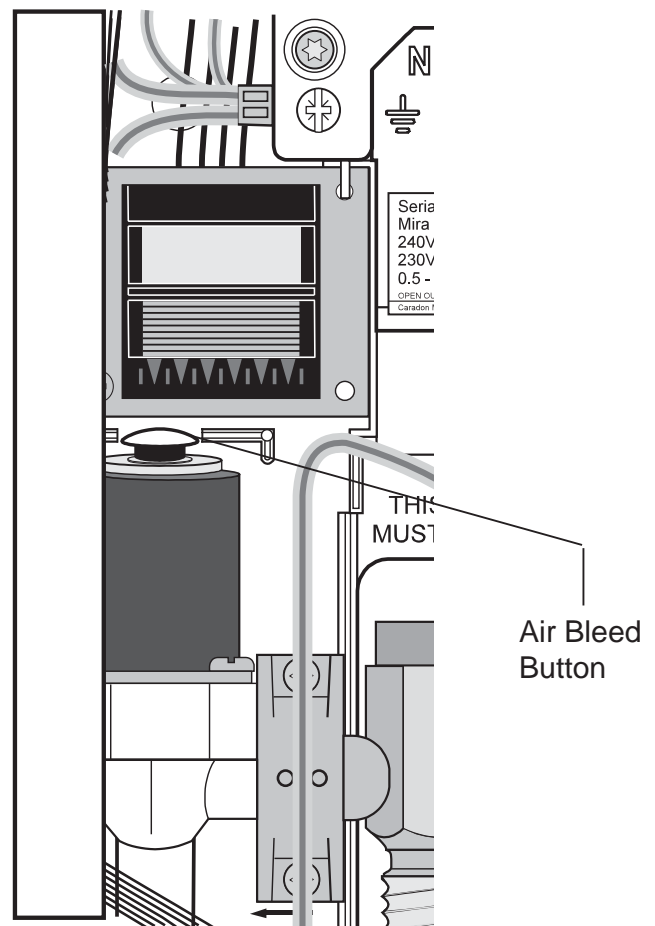

**1.16** Bring the electrical supply cable into the case via one of the cable entry points, and offer up to the terminal block.

**1.17** Strip back approximately 40 mm of the outer cable insulation. Fit the earth sleeve over the earth conductor.

**Note! DO NOT** twist the individual cable cores of the live and neutral conductors, as this will prevent them from entering the terminal block.

Connect the cables firmly into the Terminal Block Conductor Clamps. Make sure that the bare cores of each cable are securely trapped **within** each Conductor Clamp (refer to illustration).

Using a suitable screwdriver, securely tighten the Conductor Clamp Screws.

**L** = Brown Wire

**N** = Blue Wire

**E** = Yellow/Green sleeved wire

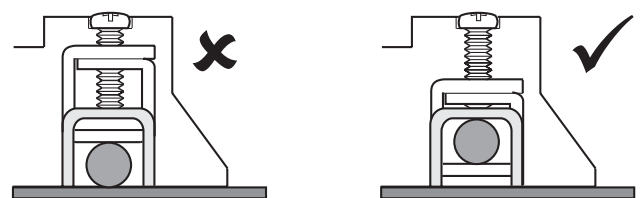
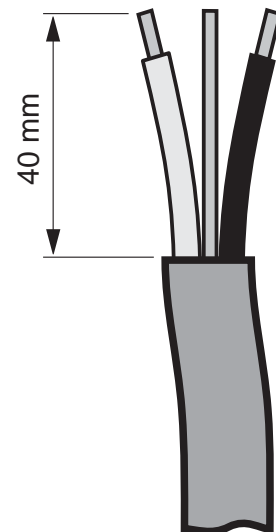

**Terminal Block  
Conductor Clamps**

**1.18** Check that the earth bonding wire to the inlet connector assembly is tight. Make sure that the 13-Way Multi-Connector lead is clear of the cover when it is refitted. Refit the inlet shield over the inlet connector assembly.

**1.19** If necessary, fit an earth bonding clamp to the copper supply pipe and make sure bonding complies with the relevant regulations in force at the time of the installation.

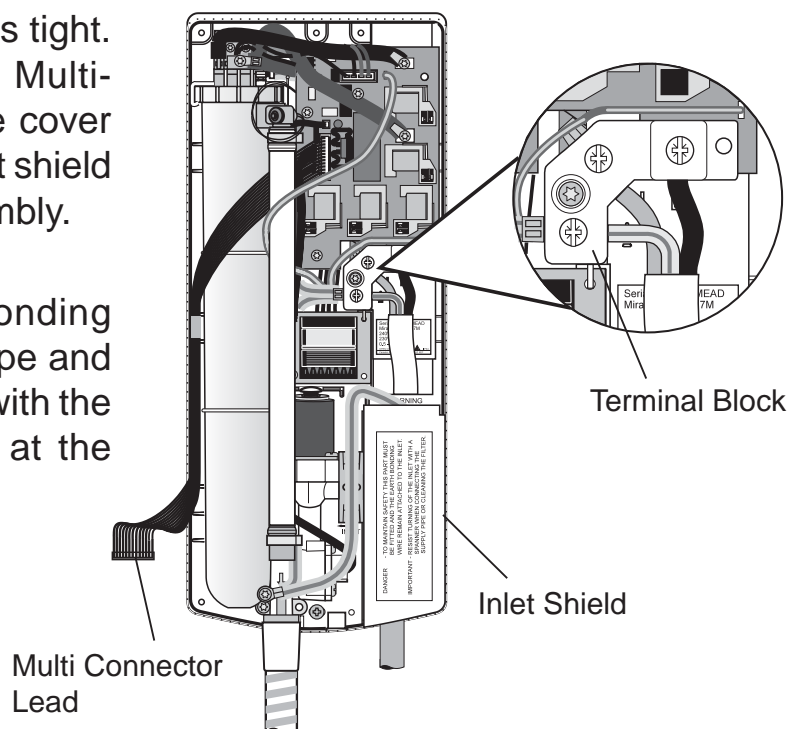

**1.19** Connect the 13-Way Multi-Connector lead from the relay board, in the Mira Advance ATL, to the socket on the control PCB located in the cover. The multi-connector is a one way fit into the receiving socket on the control PCB. Make sure that the multi-connector is correctly orientated as illustrated.

Make sure that the connector is fully pushed home.

**1.20** Make sure that the 13-Way Multi-Connector lead is seated between the tank body and the left hand side of the case, then, refit the cover by locating the top of the cover onto the location strip on the top of the case.

**1.21** Push the bottom of the cover against the case until it locates correctly. Install the screw and tighten.

**1.22** Route Pump signal cable from the product, out of the bathroom area and make connect to the pump, refer to Whale Shower Drain Pump manufacturer's recommendations (Standard Extra and Flex Extra models only).

**Note:** Polarity is not important.

**1.23** Install the shower fittings, refer to the fittings "Installation and User Guide".

**Note!** The high capacity spray plate illustrated in the shower fitting guide is not supplied with this Mira Advance ATL.

**1.24** Now proceed to commission the Mira Advance. Refer to section: "**Commissioning**".

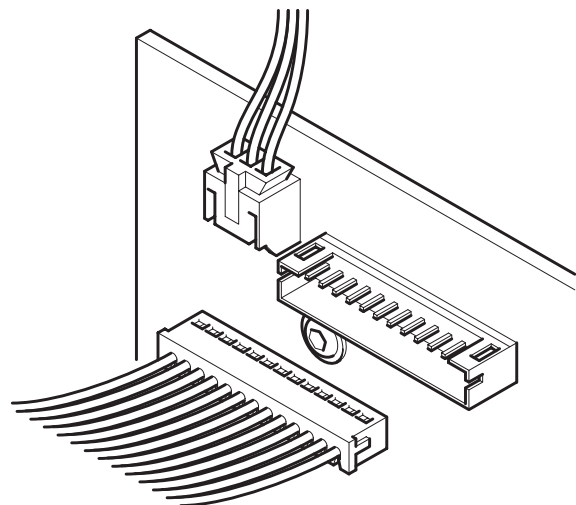
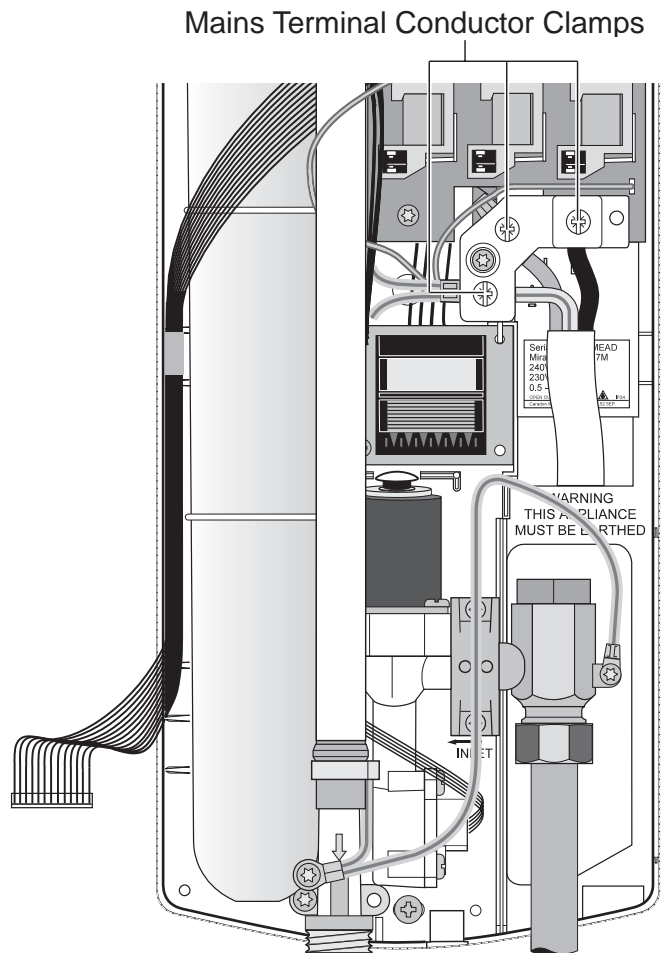

**Important!** The connector must be correctly orientated and pushed fully home

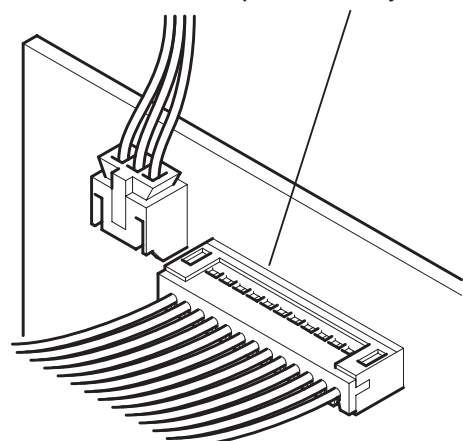

# COMMISSIONING

If you are unsure how electric showers work, refer to section: "**Operation**", before continuing.

1. Connect the flexible hose from the shower fitting to the outlet of the Mira Advance ATL. **Do not overtighten**. Over-tightening the flexible hose will shorten its life. Make sure that the hose seals are fitted, and that the handset is in the handset holder and aimed into the water catchment area.
2. Turn the "**TEMPERATURE**" control knob to **full cold**. The control knob operates clockwise from cold to hot and features a detent on the final travel to the cold only position.
3. Turn on the water supply fully at the isolating valve. Check that water is not leaking from the bottom of the case.
4. Switch on the electrical supply at the mains and test the Shower Drain Pump (if applicable, see Shower Drain Pump instructions) **before** turning the shower on. Switch on the electrical supply at the double-pole switch. The red indicator beside the "**STOP**" button will illuminate to indicate that the electrical supply is connected to the shower.
5. Press the "**LOW**" flow button and observe the green indicator with audible tone. Check that cold water flows freely from the shower within a few seconds. If a delay of more than 5 seconds is encountered, then it is likely that the Mira Advance ATL has not been primed.

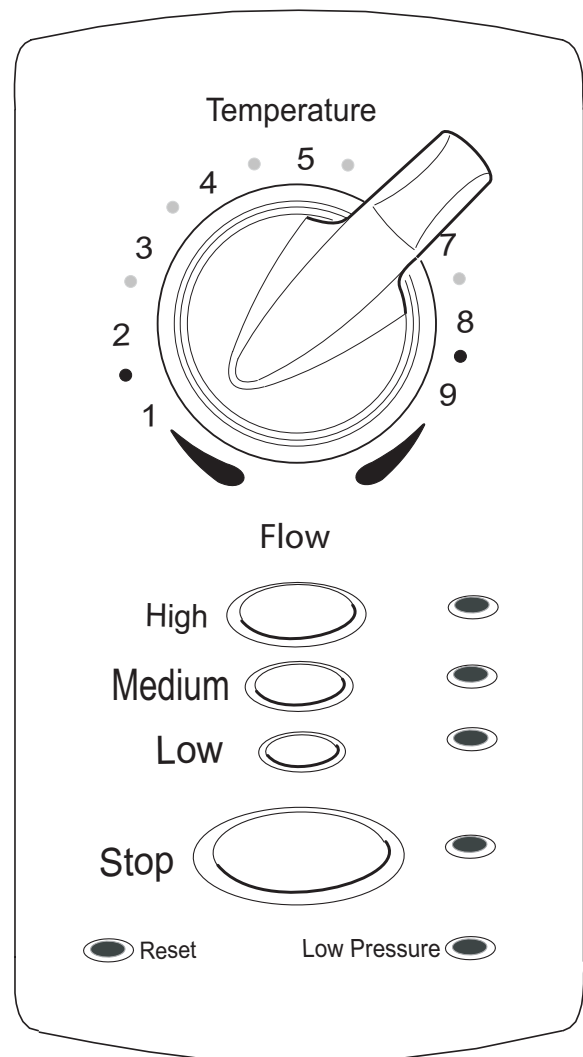

After a short delay, the Shower Drain Pump (if applicable) should operate and drain the waste water, after the shower is turned on.

Refer to section: "**Installation, Priming the Mira Advance ATL**".

**Warning!** Isolate the electrical supply. Priming requires that the Mira Advance ATL cover be removed. Should the Mira Advance ATL still not function then refer to section: '**Fault Diagnosis**'.

6. Turn the "**TEMPERATURE**" control knob to position "5" and allow the Mira Advance ATL to operate for 2 minutes. During this period the Mira Advance ATL will calibrate itself to the site conditions.

7. **Press** the "**MEDIUM**" flow button and observe an increase in flow of water, the green indicator and the audible tone. Allow the Mira Advance ATL to operate for 2 minutes.
8. **Press** the "**HIGH**" flow button and observe an increase in flow of water, the green indicator and the audible tone. Allow the Mira Advance ATL to operate for 2 minutes.
9. **Turn** the "**TEMPERATURE**" control to cold and then slowly turn from cold through to position number **6**, which is a typical showering temperature. If a satisfactory temperature cannot be achieved, then turn the "**TEMPERATURE**" control through to position number **8**.

**Note!** Changing the temperature requires the staged power up and power down of individual heating elements. During this sequence the user may hear a number of audible 'clicks' from the relays.

10. **Press** the "**MEDIUM**" flow button. The flow of water will decrease, but the selected temperature will remain relatively constant.
11. **Press** the "**LOW**" flow button. The flow of water will decrease, but the selected temperature will remain relatively constant.
12. **Press** the "**STOP**" button and observe the red indicator with audible tone. The Mira Advance ATL will continue to run for a few seconds before shutting off. Audible "clicks" will be heard.

There will be a maximum delay of up to 4 minutes before the Shower Drain Pump (if applicable) shuts down and stops draining the waste water after the shower is turned off (see Whale Shower Drain Pump Installation Guide).

**Note!** To make sure that the commissioning process is memorised by the Mira Advance ATL the **STOP** button must be pressed before electrically isolating the unit.

**Note!** Water may continue to drip for a short time whilst the water drains out of the handset .

**Note!** High cold water mains supply pressures and high shower temperatures will cause a slight audible hissing sound to be heard from the Mira Advance ATL whilst it is operating. This is quite normal and does not indicate that there is a fault with the Mira Advance ATL.

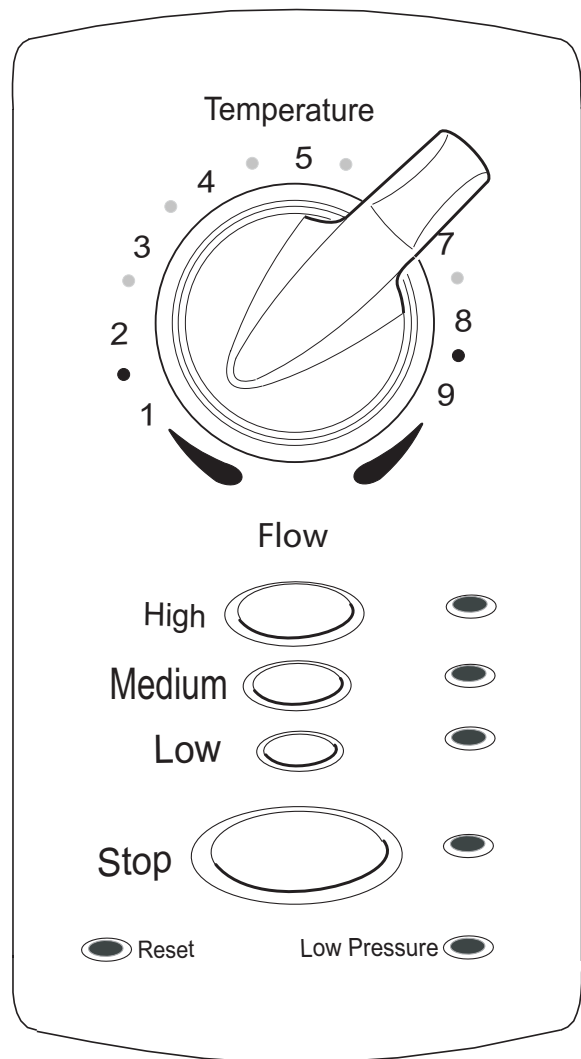



# OPERATION

## 1. How your Mira Advance ATL Shower Works

Refer to section: "**Important Safety Information**" first.

**1.1** In the event that the Mira Advance ATL fails to respond to any push-button instruction, or exhibits unusual performance characteristics during operation, first turn off the electrical supply by operating the pull-cord switch, wait for a few moments for the Mira Advance ATL to reset, then turn on the pull-cord switch and operate the Mira Advance ATL. If the problem still persists then refer to section: "**Fault Diagnosis**".

**1.2** Electric showers work by taking in cold water and passing it over heating elements contained in the tank body of the shower.

**1.3** The showering temperature is adjusted by turning the temperature control knob, which varies the flow of cold water passing over the elements. The slower the rate of flow, the warmer the shower and vice versa. The holes in the spray plate of the shower handset should always be kept clean to maintain a consistent flow and stable shower temperatures.

**1.4** Seasonal changes in the temperature of the incoming cold water supply and mains electrical voltage, will mean that the flow rate of water may vary as follows:

**Summer:** Due to the thermostatic response of the shower the flow from the Advance ATL in the summer may be higher than the flow in the autumn or spring.

**Winter:** Due to the thermostatic response of the shower the flow from the Advance ATL in the winter may be lower than the flow in the autumn or spring.

**1.5** The Mira Advance ATL monitors the following functions:

**1.5.1** The incoming cold water temperature.

**1.5.2** The outgoing shower temperature.

**1.5.3** The flow rate of water.

**1.5.4** The current user settings.

The Mira Advance ATL then calculates the flow rate and power level, to keep the outgoing temperature constant. This mode of operation requires the staged power up and power down of individual heating elements. During this sequence the user may hear a number of audible 'clicks' and the flow rate may change.

**1.6. Low Pressure Thermostatic Performance** (below 1 bar maintained)

If the supply pressure falls below 1 bar maintained, the unit may switch off elements to maintain the temperature. A reduced flow will be observed even though the user selected flow indication remains unchanged.

Restoration of the original pressure condition will not automatically restore the flow setting. This can be achieved by manually reselecting the desired flow condition.

## 1.7 Low Pressure Failure

The Mira Advance ATL contains a "**LOW PRESSURE**" indicator which will operate for three seconds, if the following conditions occur:

1.7.1 Low water pressure (below 0.5 bar maintained).

1.7.2 Blocked or partially blocked spray plate.

1.7.3 Blocked inlet filter.

If any of the above conditions occur, the unit will return to 'Stop'.

1.8 The Mira Advance ATL contains a "**RESET/SERVICE**" indicator which will operate if the following conditions occur:

1.8.1 Abnormal operating conditions, refer to section: "**Maintenance**".

1.8.2 Faulty element or element assembly.

1.8.3 Overheating

Depending on the fault condition the Advance ATL may continue to operate.

1.9 Always check the shower temperature before entering the shower. The previous user may have selected a different temperature or flow condition.

### Temperature Rise versus Flow for the Mira Advance ATL 8.7 & 9.8 kW

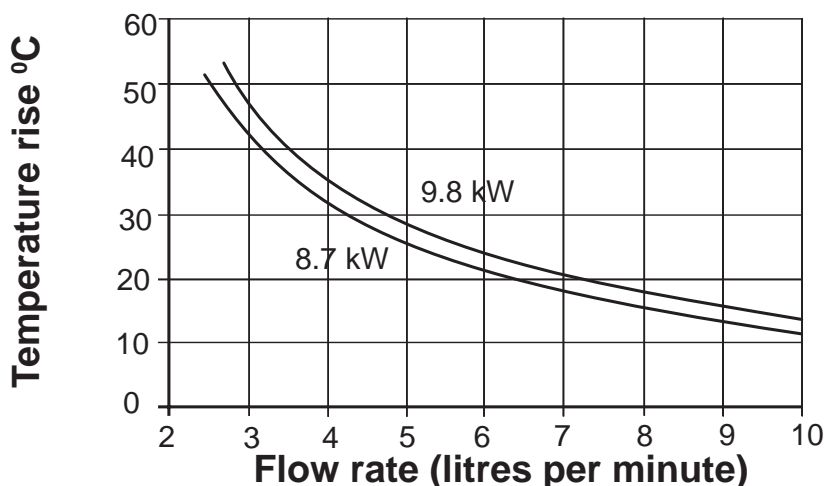

(i) The curves on the graph show the specified flow output, depending upon voltage (240 V shown) and incoming water temperature, used to calculate temperature rise.

(ii) All Mira Advance ATL heating elements have a manufacturing tolerance. Therefore flow rates can be above or below those indicated.

(iii) The left-hand scale is temperature rise. (Temperature rise = Heater tank outlet temperature minus the incoming cold water temperature.)

**Note!** Due to temperature/flow loss through the shower hose and fittings, the showering flow rate achieved may not accurately match the flow rate shown on the graph.

(iv) At pressures below 1 bar maintained the full flow performance may not be achieved, refer to 1.6. Low Pressure Thermostatic Performance.

**Example:** For the Mira Advance ATL 9.8 kW on full power setting with an incoming water supply at 10°C and a heater tank outlet temperature at 42°C, the temperature rise is 32°C. The flow rate is approximately, 4.5 l/min.

## 2. Using your Mira Advance ATL

**Important!** THE SPRAY PLATE HOLES MUST BE KEPT CLEAR. The spray plate should be regularly removed and cleaned in descalant. Lack of regular spray plate cleaning will lead to poor performance and cause early failure of the Mira Advance ATL.

**2.1** Switch on the pull-cord or wall mounted switch. The red "**STOP**" indicator on the Mira Advance ATL will provide a visual indication that the power is on.

**2.2** Press one of the three flow buttons, "**HIGH**", "**MEDIUM**" or "**LOW**". The adjacent green indicator will illuminate and an audible tone will confirm the action.

For the Advance ATL Memory, press one of the five memory buttons.

**Note!** The temperature control knob is inactive during memory control operation.

**2.3** Wait 15 - 20 seconds for warm water to reach the handset. If the "**LOW**" button was pressed then this time may be longer.

**2.4** If necessary turn the "**TEMPERATURE**" control knob clockwise to increase the temperature, or anticlockwise to decrease the temperature. Wait 10–15 seconds for the adjusted temperature to reach the handset. There will be a change in flow rate when the temperature is adjusted. The control knob operates clockwise from cold to hot and features a detent on the final travel to the cold only position.

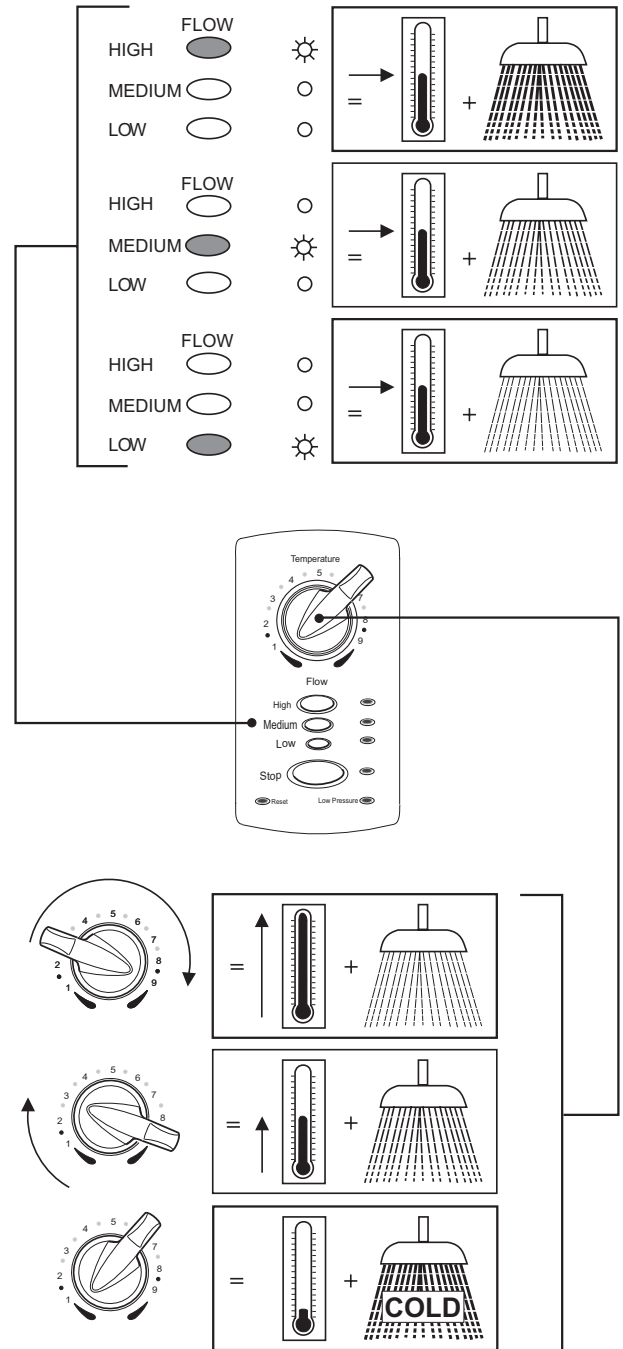

Clockwise → WARMER → less flow  
 Anticlockwise → COOLER → more flow

### Thermostatic Performance

To maintain thermostatic performance the unit may override the selected flow condition. The selected flow indicated does NOT change.

### Low Pressure Thermostatic Performance

The unit maintains thermostatic performance at low pressures, however it may be unable to achieve the desired flow conditions, refer to 1.7. Low Pressure Thermostatic Performance.



### For the Advance ATL Memory model:

To leave memory control mode, and to regain the use of the "**TEMPERATURE**" control knob press one of the following buttons; "**HIGH**", "**MEDIUM**" or "**LOW**". The shower temperature and flow rate will change from the preset memory button condition to that selected by the chosen flow button and "**TEMPERATURE**" control knob position.

**Hint!** When returning to standard control, position the '**TEMPERATURE**' control knob at the midpoint i.e. vertical.

**2.5 Important!** TO TURN OFF always press the "**STOP**" button and allow the Mira Advance ATL to perform its shutdown sequence. The red indicator will illuminate and an audible tone will confirm the action. The Mira Advance ATL will continue to run for a few seconds before stopping. This phased shutdown is to remove heat from the element assembly and tank body.

**2.6** Allow a few moments before turning off at the pull-cord switch.

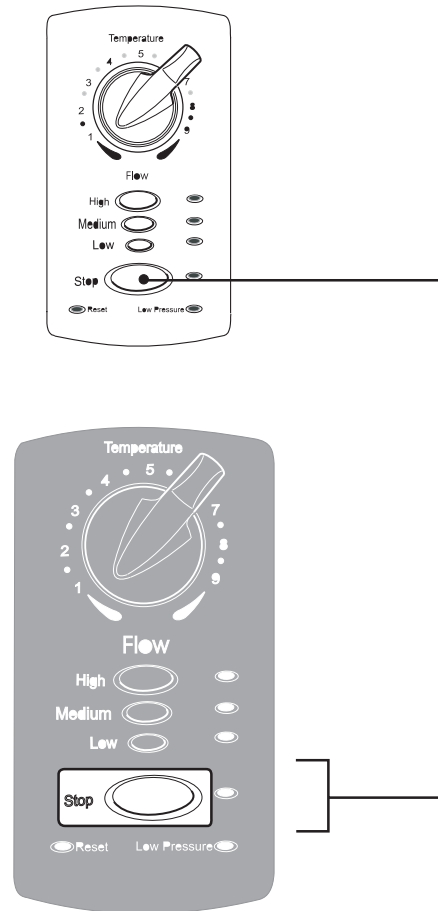

### 3. Storing the Memory Presets (Memory Control Model only):

Should you wish to change the five factory presets, proceed as follows:

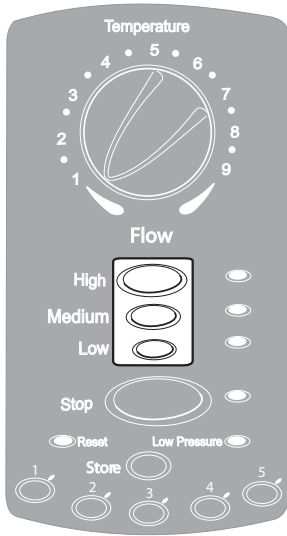

#### Step 1

Select your personal flow setting.

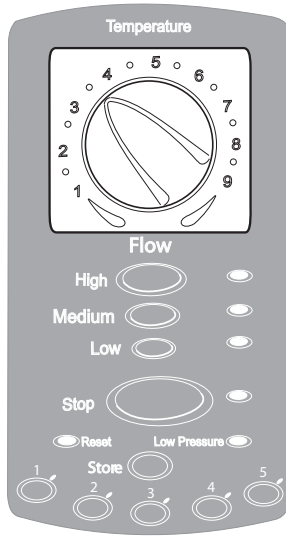

#### Step 2

Select your personal temperature setting.

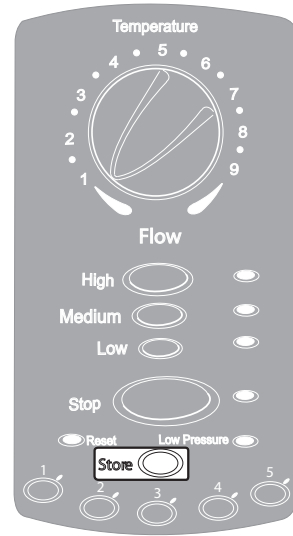

#### Step 3

Press **'STORE'**

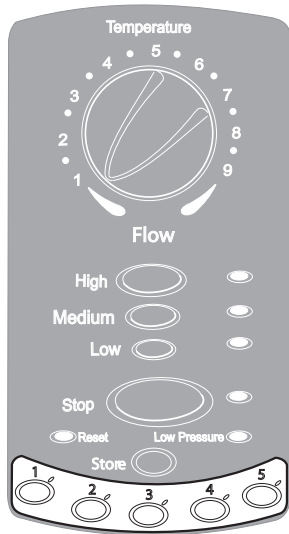

#### Step 4

Press one of the numbered preset buttons

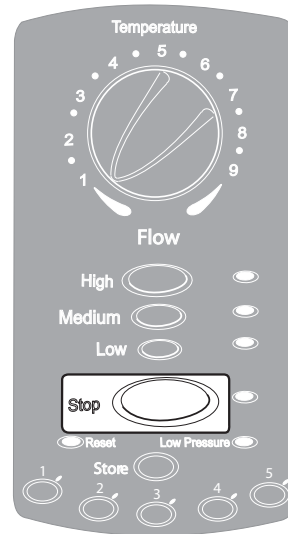

#### Step 5

Press **'STOP'** before turning off the Mira Advance ATL

**Note!** If the electrical supply is isolated without operating the stop button the memory setting will be lost. The "Storing Memory" preset procedure will need to be repeated.

# FAULT DIAGNOSIS

## 1. Users Troubleshooting Guide

The Mira Advance ATL electric shower is fully performance tested after assembly. In the unlikely event that you experience problems with the Mira Advance ATL, then the following procedures will enable you to undertake basic troubleshooting before contacting the person responsible for installing your shower.

**Warning!** There are no user serviceable components beneath the cover of the Mira Advance ATL. Only a competent tradesperson should remove the cover.

### Indicator Display

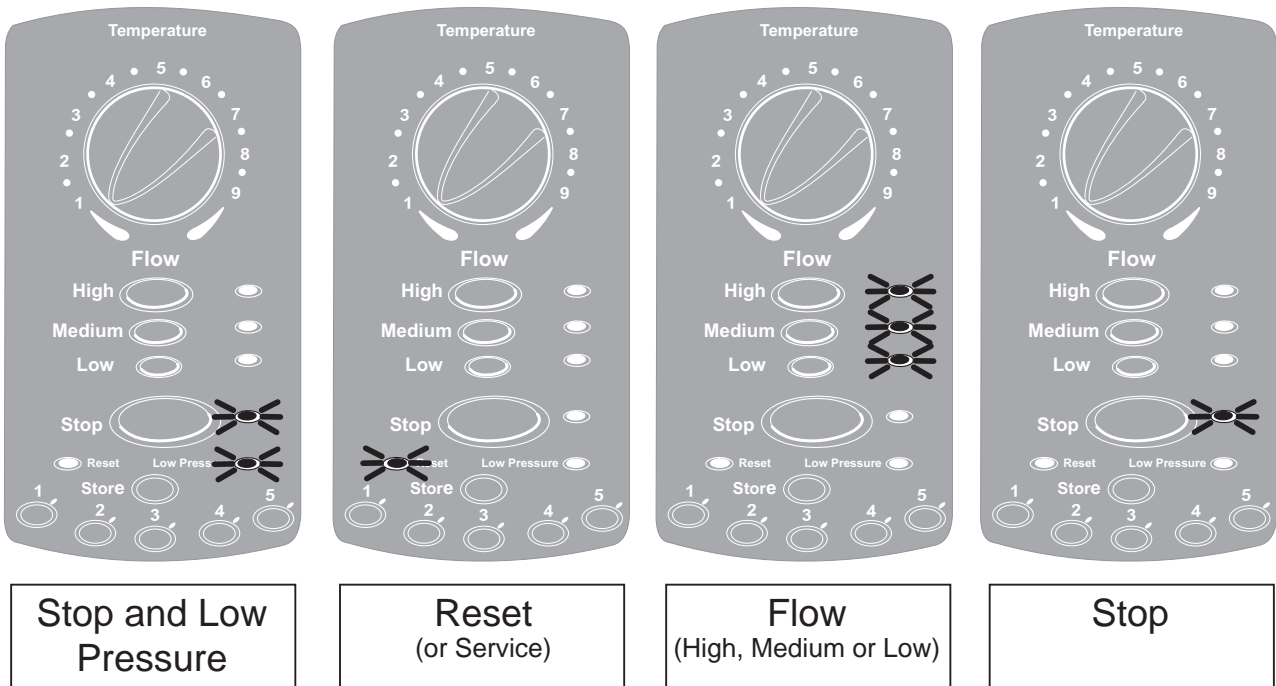

Malfunction	Indicator Display	Cause/Rectification
<ol style="list-style-type: none"> <li>No flow or very low flow rate, followed by the unit turning off.</li> <li>No flow change after button is selected.</li> </ol>	<div style="border: 1px solid black; padding: 5px; text-align: center;"> <b>Stop and Low Pressure</b> </div> <div style="border: 1px solid black; padding: 5px; text-align: center; margin-top: 10px;"> <b>Flow</b> (High, Medium or Low)                 </div>	<ol style="list-style-type: none"> <li>Blocked spray plate.</li> <li>Water supply isolating valve turned down.</li> <li>This is normal during low pressure thermostatic performance, improve the supply pressure.</li> </ol>
<ol style="list-style-type: none"> <li>Low Flow Rate.</li> <li>Sudden, rapid increase in flow for a short period, eventually returning to expected flow rate and temperature. This may occur after a period of non-use.</li> </ol>	<div style="border: 1px solid black; padding: 5px; text-align: center;"> <b>Stop and Low Pressure</b> </div> <div style="border: 1px solid black; padding: 5px; text-align: center; margin-top: 10px;"> <b>Flow</b> (High, Medium or Low)                 </div>	<ol style="list-style-type: none"> <li>Insufficient water supply pressure.</li> <li>A section of supply pipe is preheating the cold water supply to the shower. e.g. supply pipe is running through a loft or is adjacent to hot water pipes. Run the shower for a few minutes to allow the warmer water to clear the system.</li> </ol>

Malfunction	Indicator Display	Cause/Rectification
5. Water temperature is too low. 6. Shower Fails to operate when any flow button is pressed.	<div style="border: 1px solid black; padding: 5px; margin-bottom: 10px; text-align: center;">             Flow              (High, Medium or Low)           </div> <div style="border: 1px solid black; padding: 5px; text-align: center;">             No Indicators           </div>	a. Incorrect Maximum Temperature Setting. b. Check internal wiring, make sure that the 13-Way Multi-Connector is plugged in at both ends. c. Power failure or electricity supply isolated. d. Fuse failed, MCB or RCD tripped.
7. No water flow from the handset. 8. Reset/Service light flashes, flow will not stop after the 'STOP' button is pressed. 9. Any other fault condition.	<div style="border: 1px solid black; padding: 5px; margin-bottom: 10px; text-align: center;">             Stop and Low Pressure           </div> <div style="border: 1px solid black; padding: 5px; text-align: center;">             Reset              (or Service)           </div>	a. Incoming water supply temperature below 1°C, allow to thaw. b. Temporary interruption of electricity supply, following restoration press flow or memory preset button. c. Over temperature or abnormal water supply conditions, isolate electrical supply for 10 seconds to allow shower to reset. Restore the electrical supply, if the problem persists contact a competent tradesperson.
10. Visible flow change (not pulsating) without user selection. User selection lights remain unchanged.	<div style="border: 1px solid black; padding: 5px; text-align: center;">             Flow              (High, Medium or Low)           </div>	a. Variations in water supply temperature, the shower is adjusting the flow to maintain a constant showering temperature.
11. The shower shuts down when certain presets are selected <b>(Memory Model Only)</b> .	<div style="border: 1px solid black; padding: 5px; text-align: center;">             Reset              (or Service)           </div>	a. Memory presets are programmed above the maximum temperature setting. Reprogramme the memory presets.
12. The shower shuts down without any user operation.	<div style="border: 1px solid black; padding: 5px; text-align: center;">             Stop           </div>	a. For safety the shower shuts down after 30 minutes. Reselect the flow button.
13. Shower leaks from the bottom of the case.	<div style="border: 1px solid black; padding: 5px; text-align: center;">             Any           </div>	a. Isolate the electrical supply and contact a competent tradesperson.
14. No tone or continuous tone. 15. Faulty control buttons.	<div style="border: 1px solid black; padding: 5px; text-align: center;">             Reset              (or Service)           </div>	a. Faulty 13-Way Multi-Connector or control PCB. Contact a competent tradesperson.

## 2. Installers Troubleshooting Guide

Refer to section: '**Important Safety Information**' first.

**Warning!** Isolate the electrical and water supply before removing the cover.

**Warning!** Mains connections are exposed when the cover is removed.

**Warning!** Refer to wiring diagram before making any electrical connections.

**Warning!** Make sure all electrical connections are tight to prevent overheating.

**Warning!** Make sure all plumbing connections are watertight.

Providing the Mira Advance ATL has been correctly installed and is operated in accordance with the instructions contained in this guide, difficulties should not arise. If any maintenance is required then it must be carried out by a competent tradesperson for whom the fault diagnosis chart, wiring diagram and maintenance instructions are provided. Before replacing any parts make sure that the underlying cause of the malfunction has been resolved.

When following these instructions, it is sometimes necessary to examine the Mira Advance ATL with the electrical supply turned on, as well as the water supply. It is therefore essential that the appropriate safe working practices are followed in accordance with the current Health And Safety Legislation.

When the mains supply is **ISOLATED** a multimeter can be used to carry out a continuity check on certain components (e.g. supply fuse, heating elements, transformer, thermal switch, etc.).

### Indicator Display

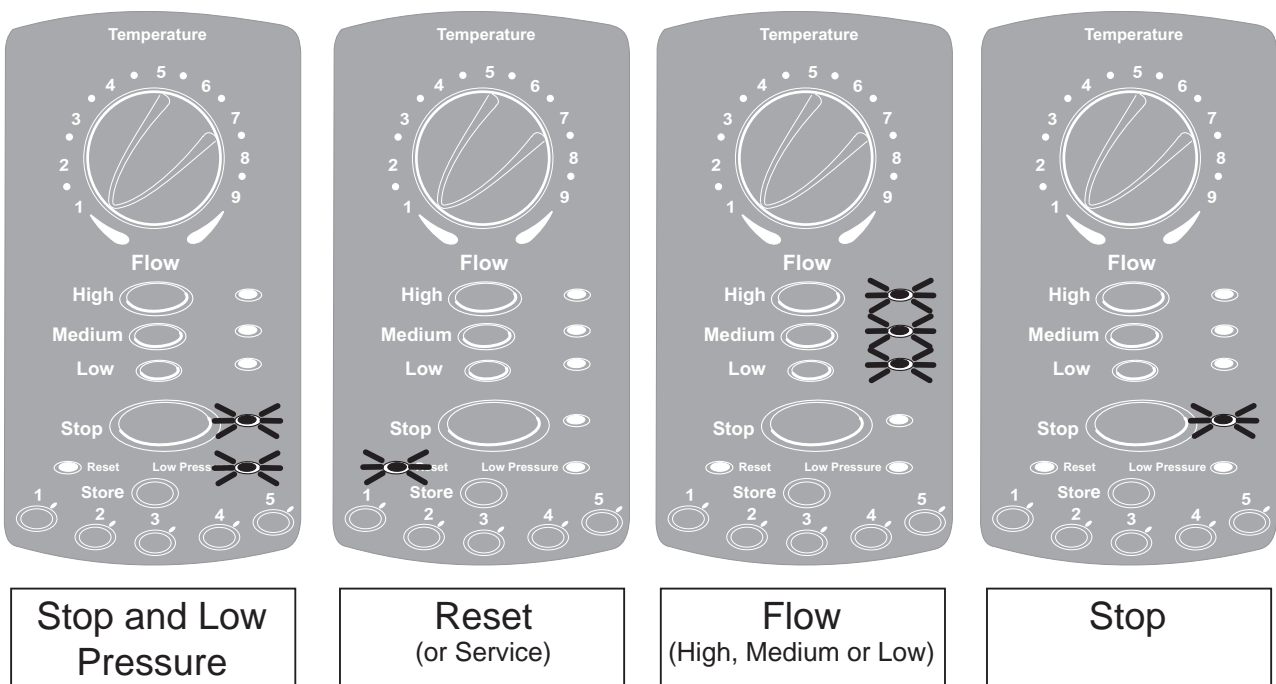

Malfunction	Indicator Display	Cause/Rectification
1. No response from shower.	<div style="border: 1px solid black; padding: 5px; width: fit-content; margin: 0 auto;">No Indicators</div>	<ul style="list-style-type: none"> <li>a. Fuse failed, MCB or RCD tripped. Rectify fault and replace or reset.</li> <li>b. Poor internal wire connections, check wire integrity, make sure 13-Way Multi-Connector is plugged in at both ends.</li> <li>c. Faulty transformer, replace.</li> <li>d. Faulty relay PCB, replace.</li> <li>e. Faulty control PCB, replace and recommission.</li> </ul>
2. No flow or very low flow rate.	<div style="border: 1px solid black; padding: 5px; width: fit-content; margin: 0 auto;">Stop and Low Pressure</div> <div style="border: 1px solid black; padding: 5px; width: fit-content; margin: 10px auto;">Stop</div>	<ul style="list-style-type: none"> <li>a. Inlet filter blocked, remove and clean or replace.</li> <li>b. Low pressure thermostatic performance, refer to section: "<b>Operation, Low Pressure Thermostatic Performance</b>".</li> <li>c. Faulty or disconnected 13-Way Multi-Connector. Reconnect or replace.</li> <li>d. Faulty relay PCB, replace.</li> <li>e. Faulty element assembly, replace and recommission.</li> <li>f. Faulty flow valve, replace and recommission.</li> <li>g. Insufficient water supply pressure, check isolating valve is fully open.</li> </ul>
3. Shower continues to drip after being turned off or will not turn off.	<div style="border: 1px solid black; padding: 5px; width: fit-content; margin: 0 auto;">Stop</div>	<ul style="list-style-type: none"> <li>a. Faulty flow valve, replace and recommission.</li> </ul>
4. Shower leaks from the bottom of the case.	<div style="border: 1px solid black; padding: 5px; width: fit-content; margin: 0 auto;">Any</div>	<ul style="list-style-type: none"> <li>a. Faulty flow valve, replace and recommission.</li> <li>b. Faulty tank assembly, replace and recommission.</li> <li>c. Broken saddle clamp/case, replace the shower.</li> <li>d. Leak from inlet connection, remake the connection.</li> </ul>
5. Control panel malfunction (e.g. no audible tone, continuous tone, indicators do not correspond with button depression).	<div style="border: 1px solid black; padding: 5px; width: fit-content; margin: 0 auto;">Any</div>	<ul style="list-style-type: none"> <li>a. Faulty control PCB, replace and recommission.</li> <li>b. Faulty or disconnected 13-Way Multi-Connector. Reconnect or replace.</li> </ul>

Malfunction	Indicator Display	Cause/Rectification
6. Shower heats water but does not get hot enough.	<div style="border: 1px solid black; padding: 5px; width: fit-content; margin: 0 auto;"> <b>Flow</b>  (High, Medium or Low) </div>	<ul style="list-style-type: none"> <li>a. Check maximum temperature setting.</li> <li>b. Faulty outlet temperature sensor, replace tank assembly and recommission.</li> </ul>
7. Shower flow rate pulsates.	<div style="border: 1px solid black; padding: 5px; width: fit-content; margin: 0 auto;"> <b>Flow</b>  (High, Medium or Low) </div>	<ul style="list-style-type: none"> <li>a. Air trapped in flow valve, isolate power and bleed.</li> <li>b. Faulty inlet sensor, replace the flow valve and recommission.</li> <li>c. Debris in flow valve, clean the turbine.</li> <li>d. Check the inlet filter is fully screwed down.</li> <li>e. Pressure above 10 bar maximum, reduce inlet pressure.</li> </ul>
8. Rapid, continuous cycling of power relays.	<div style="border: 1px solid black; padding: 5px; width: fit-content; margin: 0 auto;"> <b>Flow</b>  (High, Medium or Low) </div>	<ul style="list-style-type: none"> <li>a. Faulty inlet sensor, replace the flow valve and recommission.</li> <li>b. Debris in flow valve, clean the turbine.</li> <li>c. Check the inlet filter is fully screwed down.</li> </ul>
9. When shower is switched on reset/service light flashes and flow will not stop after stop button is pressed.	<div style="border: 1px solid black; padding: 5px; width: fit-content; margin: 0 auto;"> <b>Reset</b>  (or Service) </div>	<ul style="list-style-type: none"> <li>a. Wet electronics, dry out.</li> <li>b. Faulty relay PCB, replace.</li> </ul>
10. Faulty buttons.	<div style="border: 1px solid black; padding: 5px; width: fit-content; margin: 0 auto;"> <b>Any</b> </div>	<ul style="list-style-type: none"> <li>a. Faulty control PCB, replace and recommission.</li> </ul>
11. Intermittent reset/service light during operation. 12. Reset/service light on when flow is selected. 13. Reset/service light on and no flow.	<div style="border: 1px solid black; padding: 5px; width: fit-content; margin: 0 auto;"> <b>Reset</b>  (or Service) </div>	<ul style="list-style-type: none"> <li>a. Abnormal site conditions, isolate electrical supply for 10 seconds to allow shower to reset. Restore the electrical supply, if the problem persists contact Kohler Mira Limited.</li> <li>b. Faulty inlet sensor, replace.</li> <li>c. Debris in flow valve, clean or replace.</li> <li>d. Check the inlet filter is fully screwed down.</li> <li>e. Faulty outlet sensor, replace the tank assembly and recommission.</li> </ul>

**The following malfunction relates to the Standard Extra and Flex Extra models when connected to the Whale Shower Drain Pump.**

Malfunction	Indicator Display	Cause/Rectification
14. Water not draining.	<div style="border: 1px solid black; padding: 5px; width: fit-content; margin: auto;"> <p style="text-align: center;">Flow (High, Medium or Low)</p> </div>	<p>Switch on the electrical supply at the mains and test the Shower Drain Pump (see Whale Shower Drain Pump Installation Guide).</p> <p>a. If pump is operating there is a signal problem from the Mira Advance ATL. Refer to "To Contact Us" on the back page of this guide.</p> <p>b. If pump is not operating there is a problem with the drain pump or power supply. Refer to the Whale Pump manufacturer's installation guide for further customer support.</p>



# MAINTENANCE

## 1. General

Refer to section: "**Important Safety Information**" first.

Providing the shower has been correctly installed and is operated in accordance with the instructions contained in this guide, difficulties should not arise. If any maintenance is required then it must be carried out by a competent tradesperson for whom the maintenance instructions are provided. Before replacing any parts make sure that the underlying cause of the malfunction has been resolved.

**Warning!** There are no user serviceable components beneath the cover of the appliance. Only a competent tradesperson should remove the cover.

## 2. Cleaning

**2.1** Many household cleaners contain abrasives and chemical substances, and should not be used for cleaning plated or plastic fittings. These finishes should be cleaned with a mild washing up detergent or soap solution, and then wiped dry using a soft cloth.

**2.2** Spray pattern deterioration can be caused by either, debris trapped in the spray head, or a limescale build-up in the spray holes. The spray head can be removed and cleaned in a proprietary plastic kettle descalant, following the manufacturer's instructions.

**2.3** To clean the head or spray plate, please refer to the appropriate section in the Installation and User Guide which accompanies the shower fittings.

### 2.4 Inlet Filter

**Warning!** Isolate the electrical and water supplies before removing the cover.

**2.4.1** Remove the Cover, refer to section: "**Maintenance, 3. Cover, Removal and Reassembly**".

**2.4.2** Remove the Inlet Shield.

**2.4.3** Hold a wrench across the flats of the Inlet Connector Assembly to prevent damage, and unscrew the Inlet Filter.

**2.4.4** Pull out and clean or renew the Inlet Filter.

**2.4.5** Refit in reverse order. Make sure that the Inlet Filter is screwed fully home and check for leaks.

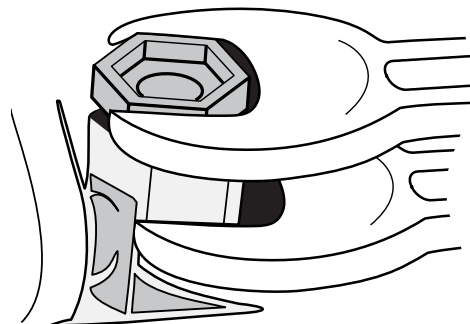

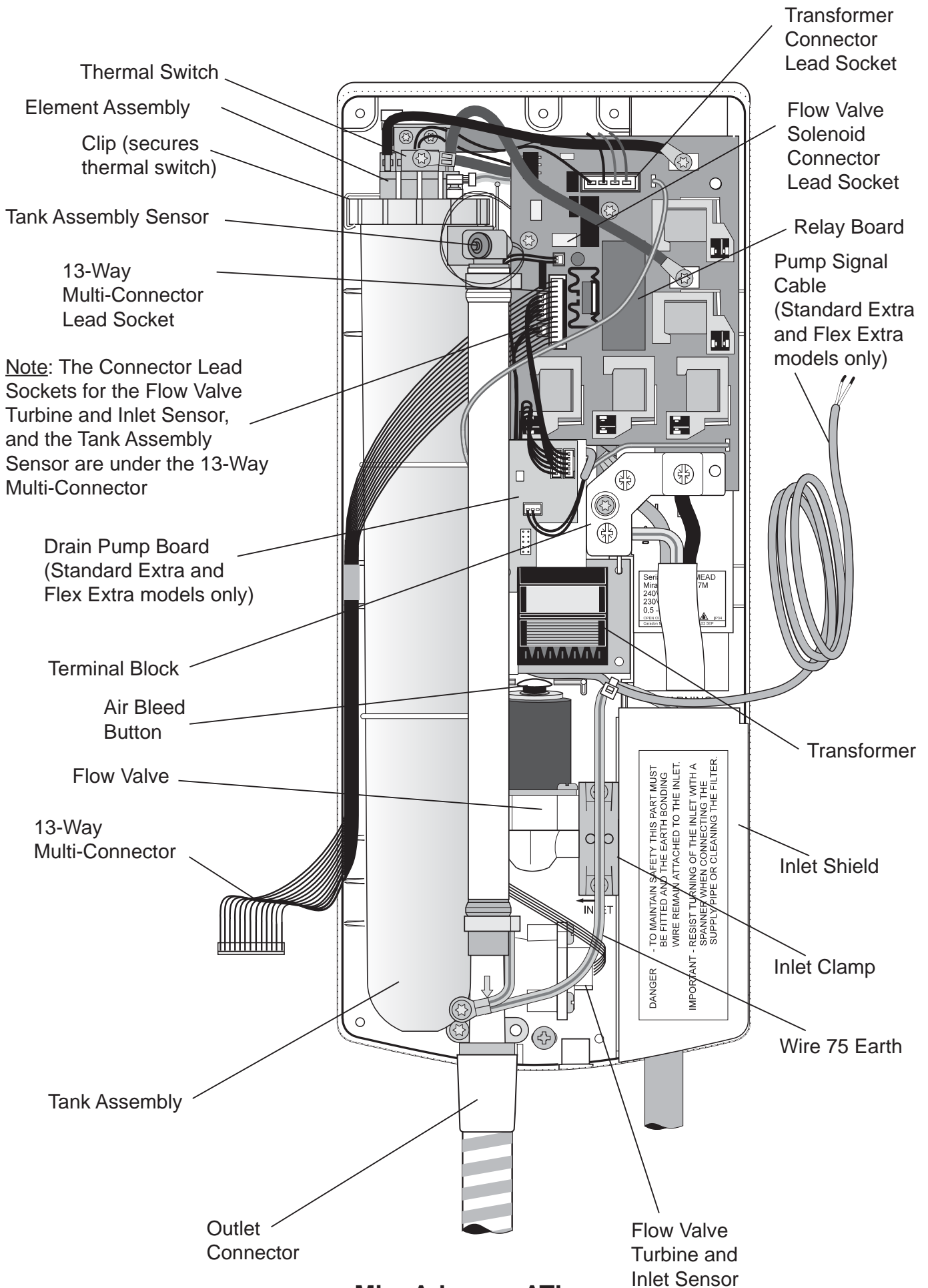

### 3. Cover

**Warning! Isolate Electrical and Water supplies before removing the cover.**

#### Removal

- 3.1 Unscrew the Cover Retaining Screw from the bottom of Case.
- 3.2 Carefully pull the bottom of the Cover outwards and upwards off the Case.  
**Caution!** Do not strain the 13-Way Multi-Connector.
- 3.3 Carefully, remove the 13-Way Multi-Connector from the socket on the Control PCB in the Cover.

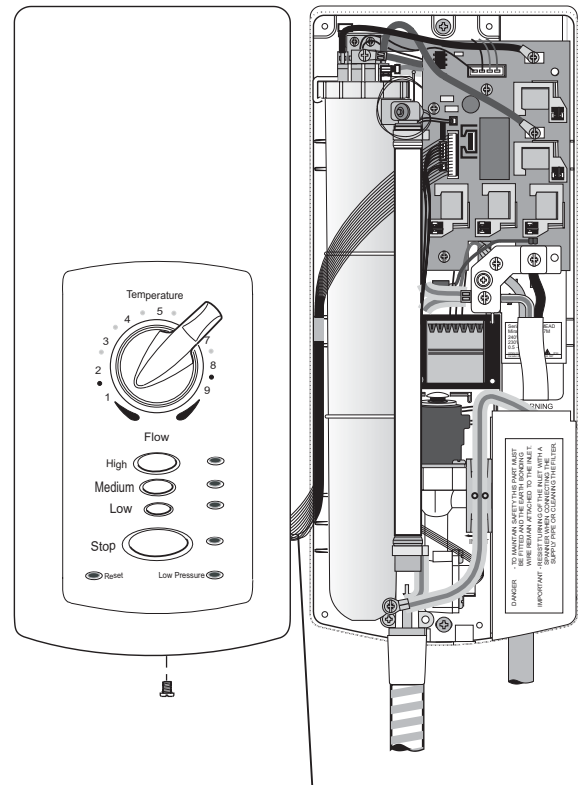

13-Way Multi-Connector

#### Reassembly

- 3.4 Connect the 13-Way Multi-Connector to the Socket on the Control PCB. The 13-Way Multi-Connector lead plug is a one way fit into the socket and must be pushed fully home.
- 3.5 Refit the Cover by locating the top of the cover onto the location strip on top of the case. Make sure that the 13-Way Multi-Connector lead is seated between the Tank Assembly and the left-hand side of the Case.
- 3.6 Push the bottom of the Cover against the case until it locates correctly. Refit and tighten the Cover Retaining Screw.

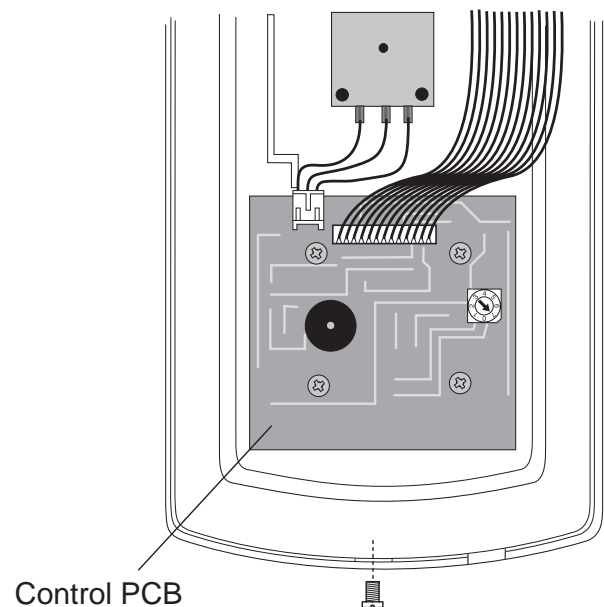

## 4. Relay Board

### Replacement

4.1 Remove the Cover, refer to section: "**Maintenance, 3. Cover, Removal and Reassembly**".

**Important!** Make a note of the wire positions and routing.

4.2 Remove all of the Plug-in Connectors from the Relay Board.

4.3 Remove the Terminal Block Cover Retaining Screw and remove the Terminal Block Cover.

4.4 Remove the Wires to the Element Assembly.

4.5 Remove the two Earth Fly Leads.

4.6 Remove the Relay Board Retaining Screws.

4.7 Remove and discard the Relay Board.

4.8 Fit the new Relay Board in the reverse order.

**Warning!** Make sure all electrical connections are securely tightened and correctly routed.

## 5. Transformer

### Replacement

5.1 Remove the Cover, refer to section: "**Maintenance, 3. Cover, Removal and Reassembly**".

**Important!** Make a note of the wire positions and routing.

5.2 Remove all of the Plug-in Connectors from the Relay Board.

5.3 Remove the Terminal Block Cover Retaining Screw and remove the Terminal Block Cover.

5.4 Remove the Wires to the Element Assembly.

5.5 Remove the two Earth Fly Leads.

5.6 Remove the Relay Board Retaining Screws.

5.7 Remove the Relay Board.

5.8 Remove the Thermal Switch from the clip at the top of the Tank Assembly.

5.9 Remove the Transformer Retaining Screw and remove and discard the Transformer.

5.10 Fit the new Transformer in the reverse order.

**Warning!** Make sure all electrical connections are securely tightened and correctly routed.

## 6. Inlet Connector Assembly

### Replacement

6.1 Remove the Cover, refer to section: "**Maintenance, 3. Cover, Removal and Reassembly**".

- 6.2 Remove the Inlet Shield.
- 6.3 Remove the Earth Bonding Screw and Wire.
- 6.4 Remove the Inlet Clamp Retaining Screws and remove the Inlet Clamp.
- 6.5 Undo the Compression Nut, remove and discard the Inlet Connector.
- 6.6 Fit the new Inlet Connector in the reverse order.

**Warning!** Make sure that the Earth Bonding Wire is fitted and securely tightened.

## 7. Flow Valve

### Replacement

- 7.1 Remove the Cover, refer to section: "**Maintenance, 3. Cover, Removal and Reassembly**".

**Important!** Make a note of the wire positions and routing.

- 7.2 Remove the Shower Hose.
- 7.3 Remove the Inlet Shield.
- 7.4 Remove the Hose Outlet Connector Retaining Screw.
- 7.5 Locate the release tab for the Hose Outlet Connector (underneath the metal clip on the flexible outlet pipe).
- 7.6. Rest a screwdriver on the interconnecting pipe to the Flow Valve. Gently lever the tab upwards.  
**Caution!** Do not try and force the Outlet Connector off by hand.
- 7.7 Move the Flexible Outlet Pipe away to the right of Flow Valve.
- 7.8 Lift and partially separate the Flow Valve from the outlet of Heater Tank Assembly. Allow the water to drain out of the bottom of Mira Advance ATL.
- 7.9 Remove the Flow Valve Turbine and Inlet Sensor Connector Lead (5 wires) from the Relay Board.
- 7.10 Remove the Flow Valve Solenoid Connector Lead (2 wires) from the Relay Board.
- 7.11 Remove the Inlet Clamp Retaining Screws and remove the Inlet Clamp.
- 7.12 Separate the Flow Valve from the Tank Assembly and Inlet Connector and discard.
- 7.13 Replace the Inlet Filter, refer to Section: "**Maintenance, 2.4 Inlet Filter**".
- 7.14 Fit the new Flow Valve in the reverse order.

**Warning!** Make sure all electrical connections are securely tightened and correctly routed.

- 7.15 Reprime the appliance, refer to Section: "**Installation, Priming The Mira Advance ATL**".
- 7.16 Recommission the Mira Advance ATL, refer to section: "**Commissioning**".

## 8. Tank Assembly

### Replacement

- 8.1 Refer to section: "**7. Flow Valve**" and follow instructions **7.1 to 7.8**.
- 8.2 Remove the Earth Bonding Screw and Wire from the Outlet Connector.
- 8.3 Remove the Tank Assembly Connector Lead (2 wires) from the Relay Board and remove the Thermal Switch from the clip.
- 8.4 Remove the Inlet Clamp Retaining Screws and remove the Inlet Clamp.
- 8.5 Separate the Tank Assembly from the Flow Valve and discard.
- 8.6 Fit the new Tank Assembly in reverse order.  
**Warning!** Make sure all electrical connections are securely tightened and correctly routed.  
**Note!** When fitting the Earth Wire to the Outlet Connector, fully tighten the Shower Hose first to make sure that the seal inside the Outlet Connector is fully compressed.
- 8.7 Recommission the Mira Advance ATL, refer to section: "**Commissioning**".

## 9. Pump Driver Board

### Replacement

- 9.1 Remove the Cover, refer to section: "**Maintenance, 3. Cover, Removal and Reassembly**".  
**Important!** Make a note of the wire positions and routing.
- 9.2 Remove all of the Plug-in Connectors from The Pump Driver Board.
- 9.3 Remove the Pump Board Retaining Screw and Washer.
- 9.4 If necessary, replace the PCB Insulator and Washer.
- 9.5 Replace the Pump Board.
- 9.6 If necessary, replace the 2-way Signal Cable and/or the 5-way Sensor Cable.  
Note: If replacing the Signal Cable it will be necessary to remove the Transformer. Refer to section: "**Maintenance, 5. Transformer, Replacement**".
- 9.7 Recommission the Mira Advance ATL and the Whale Shower Drain Pump, refer to section "**Commissioning**".



# MAXIMUM TEMPERATURE SETTING

The Mira Advance ATL has been factory set to deliver a maximum water temperature of 48°C. If the shower is to be operated within a healthcare or special needs environment, it is recommended that you carry out the procedure detailed below.

The Mira Advance ATL is capable of limiting the maximum water temperature to between 37°C and 48°C.

**Example:** If the Temperature Restriction Dial has been set to correspond with position 4 (41°C), then the maximum showering temperature of 41°C will be achieved at approximately position 6 on the 'Temperature Knob' on the Front Cover of the Shower. Further clockwise movement of the 'Temperature Knob' will not increase the showering temperature.

**Note!** Advance ATL Memory: Selecting a temperature preset that was previously set above the new maximum temperature setting will cause the shower to shut down automatically. This is a safety precaution.

## To adjust the Maximum Temperature Setting:

1. Remove the Cover, refer to section: '**Maintenance, 3. Cover, Removal and Reassembly**'.

**Note!** There is no need to remove the 13-Way Multi-Connector.

2. Using a small screwdriver, rotate the "**Temperature Restriction Dial**" to the desired setting.
3. Refit the Cover.

Restriction Dial Setting	
Position	Temp °C
0	37
1	38
2	39
3	40
4	41
5	42
6	45
7	48

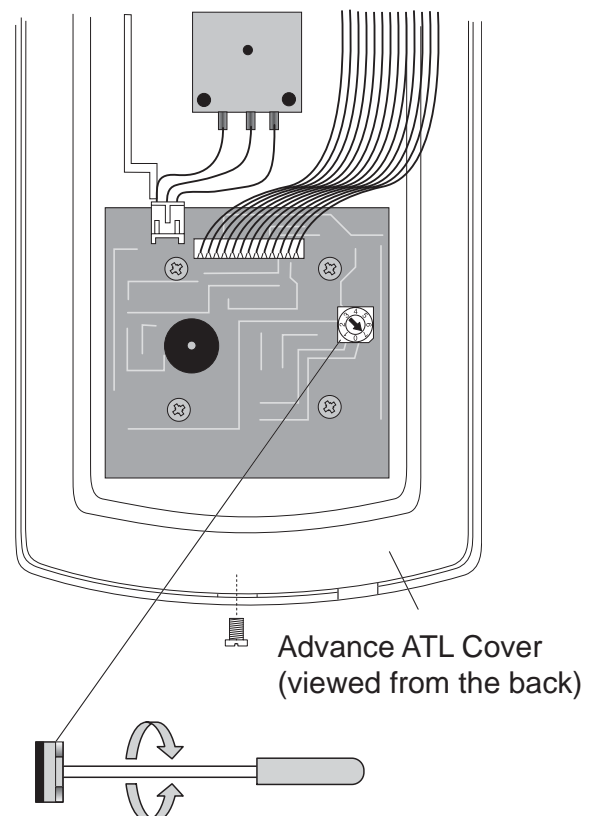

Rotate the arrow on the Temperature Restriction Dial to set the desired maximum water temperature

## SPARE PARTS

405 50	Inlet Sensor
405 56	13-Way Multi-Connector
405 58	Inlet Connector Assembly
406 19	Tank Assembly 9 kW/230 V 9.8 kW/240 V
406 20	Tank Assembly 8 kW/230 V 8.7 kW/240 V
406 22	Transformer
406 25	Seal Pack (components identified "A")
406 27	Inlet Filter
406 28	Component Pack (components identified "B")
406 46	Terminal Block
406 88	Relay Board and Earth Wire
430 40	Top Case Insert
430 45	Service Tunnel (Inlet Shield)
430 60	Control PCB - <b>Standard and Flex models only</b>
430 61	Control PCB - <b>Memory model only</b>
430 62	Cover Assembly - <b>Standard model only</b>
430 63	Cover Assembly - <b>Memory model only</b>
430 64	Cover Assembly - <b>Flex model only</b>
430 65	Flow Valve Assembly (components identified "C")
1566.087	Drain Pump Board Assembly

## ACCESSORIES

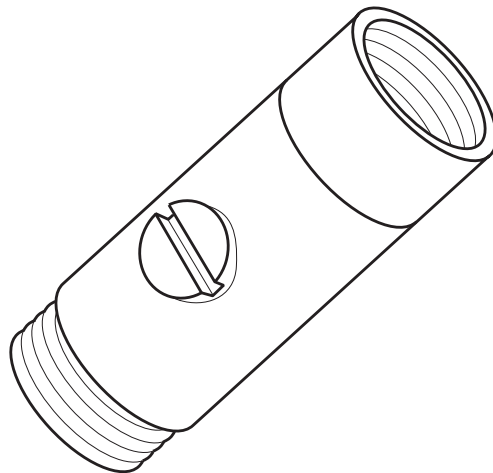

**DCV-H:** An outlet double check valve, designed to prevent the backflow or backsiphonage of potentially contaminated water, through shower controls which are fitted with a flexible hose as part of the outlet shower fitting. Available as an optional accessory from your Mira Showers stockists.



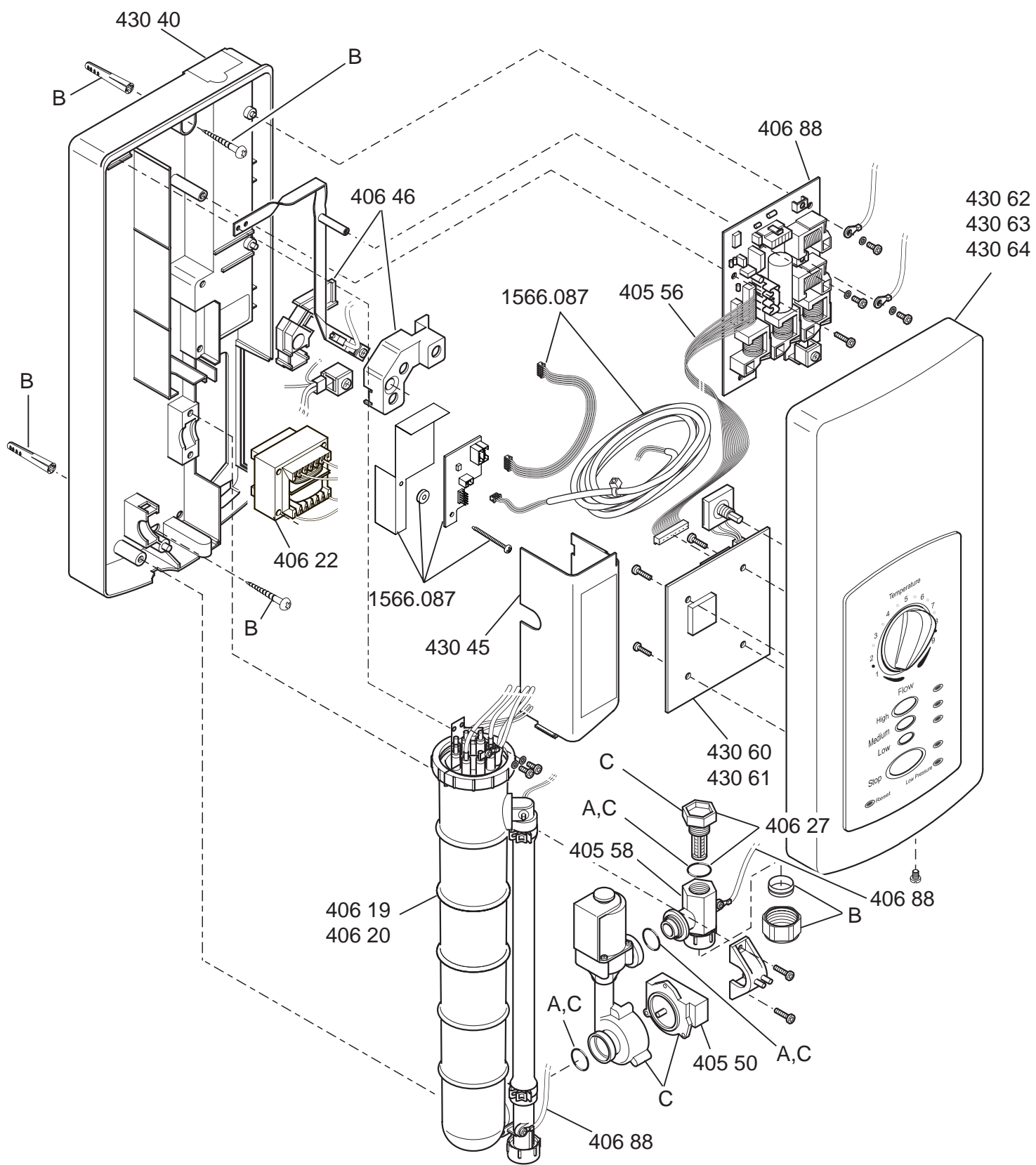

# NOTES

# NOTES

# CUSTOMER SERVICE

## Guarantee of Quality

Mira Showers guarantee your product against any defect in materials or workmanship for the period shown in the Guarantee Registration Document included with your shower.

Alternatively, to confirm the applicable guarantee period please contact Customer Services.

To validate the guarantee, please return your completed registration card.

Within the guarantee period we will resolve defects, free of charge, by repairing or replacing parts or modules as we may choose.

To be free of charge, service work must only be undertaken by Mira Showers or our approved agents in Northern Ireland and Republic of Ireland.

Service under this guarantee does not affect the expiry date.

The guarantee on any exchanged parts or product ends when the normal product guarantee period expires.

Not covered by this guarantee:

Damage or defects arising from incorrect installation, improper use or lack of maintenance, including build-up of limescale.

Damage or defects if the product is taken apart, repaired or modified by any person not authorised by Mira Showers or our approved agents.

This guarantee is in addition to your statutory and other legal rights.

## Before using your shower

Please take the time to read and understand the operating and safety instructions detailed in this manual.

## What to do if something goes wrong

If when you first use your shower it doesn't function correctly, first contact your installer to check that installation and commissioning are satisfactory and in accordance with the instructions in this manual. We are on hand to offer you or your installer any advice you may need.

Should this not resolve the difficulty, simply contact our Customer Services who will give every assistance, and if necessary arrange for our service engineer to visit.

If later the performance of your shower declines, consult this manual to see whether simple home maintenance is required. Please call our Customer Services to talk the difficulty through, request service under guarantee if applicable, or take advantage of our comprehensive After-Sales service.

As part of our quality and training programme calls may be recorded or monitored.

Our Customer Services Team is comprehensively trained to provide every assistance you may need: help and advice, spare parts or a service visit.

## Spare Parts

We maintain an extensive stock of spares, and aim to have functional parts available for eight years from the date of final manufacture of the product.

Spares can be purchased from approved stockists or merchants (locations on request) or direct from Customer Services.

Spares direct will normally be despatched within two working days. Payment can be made by Visa or MasterCard at the time of ordering. Should payment by cheque be preferred a pro-forma invoice will be sent.

**Note!** In the interests of safety, spares requiring exposure to mains voltages can only be sent to competent persons.

## Service

Our Service Force is available to provide a quality service at a reasonable cost. You will have the assurance of a Mira trained engineer/agent, genuine Mira spares, and a 12 month guarantee on the repair.

Payment should be made directly to the Service Engineer/Agent, using Visa, MasterCard or a cheque supported by a banker's card.

## To Contact us

England, Scotland & Wales

### Mira Showers Customer Services

Telephone: 0870 241 0888 - Mon to Fri 8:00 am - 5:30 pm  
Sat 9:00 am - 4:00 pm

E-mail: [technical@mirashowers.com](mailto:technical@mirashowers.com)

Fax: 01242 282595

By Post: Cromwell Road, Cheltenham  
Gloucestershire, GL52 5EP

Northern Ireland

### Wm H Leech & Son Ltd

Telephone: 028 9044 9257 - Mon to Fri 9:00 am - 5:00 pm

E-mail: [leech@dnet.co.uk](mailto:leech@dnet.co.uk)

Fax: 028 9044 9234

Post: Maryland Industrial Estate  
Ballygowan Road, Moneyreagh  
Co Down, BT23 6BL

Republic of Ireland

### Modern Plant Ltd (Dublin)

Telephone: 01 459 1344 - Mon to Fri 9:00 am - 5:00 pm

E-mail: [sales@modernplant.ie](mailto:sales@modernplant.ie)

Fax: Dublin 01 459 2329

Post: Otter House, Naas Road  
Clondalkin, Dublin 22

### Modern Plant Ltd (Cork)

Telephone: 021 496 8755 - Mon to Fri 9:00 am - 5:00 pm

E-mail: [cork@modernplant.ie](mailto:cork@modernplant.ie)

Fax: 021 496 8607

Post: Tramore Road, Cork

**Mira Showers**  
Kohler Mira Ltd  
Cromwell Road,  
Cheltenham GL52 5EP.

Mira is a registered trade mark of  
Kohler Mira Limited.  
The company reserves the right to alter  
product specifications without notice.  
[www.mirashowers.com](http://www.mirashowers.com)



**mira**  
SHOWERS